

Cintiq[®] 21UX

**Installation Guide & Hardware Manual
for Cintiq 21UX (DTZ-2100D)**



Wacom Cintiq® 21UX

Installation Guide & Hardware Manual for Cintiq 21UX (DTZ-2100D)

English version 2.2, November 05, 2007

Copyright © Wacom Co., Ltd., 2007

All rights reserved. No part of this manual may be reproduced except for your express personal use.

Wacom reserves the right to revise this publication without obligation to provide notification of such changes.

Wacom does its best to provide current and accurate information in this manual. However, Wacom reserves the right to change any specifications and product configurations at its discretion, without prior notice and without obligation to include such changes in this manual.

DuoSwitch is a trademark, and Cintiq and Wacom are registered trademarks of Wacom Co., Ltd.

Photoshop is either a registered trademark or a trademark of Adobe Systems Incorporated in the United States and/or other countries. Microsoft, Windows, and Vista are either registered trademarks or trademarks of Microsoft Corporation in the United States and/or other countries. Apple, the Apple logo, and Macintosh are trademarks of Apple Computer, Inc., registered in the U.S. and other countries.

Any additional company and product names mentioned in this documentation may be trademarked and/or registered as trademarks. Mention of third-party products is for informational purposes only and constitutes neither an endorsement nor a recommendation. Wacom assumes no responsibility with regard to the performance or use of these products.

ExpressKey is a registered trademark of Ginsan Industries, Inc., and is used with permission.

INTRODUCTION AND OVERVIEW

The Wacom® Cintiq® 21UX pen display combines the benefits of a Liquid Crystal Display (LCD) with the control, comfort, and productivity of Wacom's cordless, battery-free pen technology. This gives you a direct pen-on-screen interface for your computer.

Cintiq's basic components include a Wacom pen tablet internally mounted behind a 21.3" diagonal TFT color display, and Wacom's Grip Pen.

Cintiq comes with a modular display stand, which allows you to easily rotate the pen display to any orientation, and to adjust the incline of the working surface to any angle between 10 and 65 degrees. Please refer to *Working with your Cintiq* on page 24 for more information.

This manual describes how to install the Cintiq hardware and software. It also describes how to use Cintiq, the Grip Pen, and the modular display stand.

See *Unpacking your Cintiq* on page 8 before setting up the Cintiq stand or unpacking the Cintiq pen display. **Please follow all instructions carefully.**

The computer treats the Cintiq pen display as two separate devices (the display and the pen tablet). Therefore, the installation process is completed in two stages:

- First install the Cintiq as a display.
- Then install the Cintiq as a pen tablet.

Both stages require hardware and software installations and adjustments. **Please follow all instructions carefully.**

IMPORTANT: You MUST install the Wacom pen tablet driver software for correct pen-on-screen functionality.

To learn about using the Wacom Tablet control panel to customize your pen display tablet and pen settings on Windows or Macintosh computers, see *Customizing* on page 32.

To use the pressure sensitivity of the Grip Pen with your favorite drawing application, see the instructions in that application's manuals.

The following kinds of information are not included with this product: information about your specific computer hardware or operating system, or information about your application software. Your best source for this information is the set of manuals and discs that came with your hardware, operating system, or application.

Wacom's philosophy is to continually improve all of its products. As a result, engineering changes and improvements are made from time to time. Therefore, some changes, modifications, and improvements may not be covered in this manual.

PRECAUTIONS ON USE AND HANDLING

To ensure the safe usage of your product, be sure to follow all instructions, cautions, and warnings found within this manual. Failure to do so could cause the loss of data or damage to your computer. Failure to do so could also void your warranty, in which case Wacom shall have no responsibility to repair or replace the product.



WARNING

This symbol indicates an item that, if disregarded, may lead to loss of human life or serious injury.



CAUTION

This symbol indicates an item that, if disregarded, may lead to human injury or damage to personal property.

Exercise due care and diligence whenever engaging in a described action.

PHYSICAL LOCATION



WARNING

Do not use the Cintiq pen display in a facility control system that requires extremely high reliability; it may cause other electronic devices to malfunction, or other devices may cause the pen display tablet to malfunction. Where use is prohibited, power off Cintiq to prevent the possibility of it causing other electronic devices to malfunction. Wacom does not accept any liability for direct or consequential damages. For details, please refer to your Warranty located at the end of this manual.

ENVIRONMENT

Temperature and Humidity

- Operating temperature and humidity: 5° to 35°C, 20 to 80% RH
- Storage temperature and humidity: -10° to 60°C, 20 to 90% RH



CAUTION

Do not use or store Cintiq where:

- Temperature changes are severe or exceed specifications (e.g., outdoors or inside a vehicle).
- The pen display, the Grip Pen, and the Cintiq stand are exposed to direct sunlight or heat from an appliance, or are exposed to water or any other kind of liquid.



CAUTION

Do not use Cintiq in a dusty environment; this may damage the unit.

USAGE



WARNING

Only use the power adapter that came with Cintiq. If a different type of power adapter is used, Cintiq will not work properly or may be damaged. **Using a different type of power adapter also has the potential to result in fire.** Use of a different power adapter will void your warranty.



CAUTION

Be sure to use a grounded power source when applying power to Cintiq.



CAUTION

Do not connect or disconnect the video or power cables while Cintiq or your computer are turned on; this may damage the display or computer video card. In this case, Wacom shall have no responsibility to repair or replace the product.



CAUTION

This product is for use with a DVI or VGA video card; using an inappropriate video card may damage Cintiq.



CAUTION

Do not block the rear panel ventilation holes; this may overheat and damage the unit.

When not using Cintiq for long periods of time, unplug the power adapter from the AC outlet.

HANDLING



WARNING

High Voltage. Do not open or disassemble the Cintiq pen display. There is a risk of electrical shock when the casing is open. This will also void your warranty and Wacom shall have no responsibility to repair or replace the product.



WARNING

Do not operate the display stand incline adjustment levers when Cintiq is not mounted on the stand, and do not lift the stand by the adjustment levers; the stand is spring-loaded and may cause injury or damage if released without the weight of Cintiq on the stand. Improper operation may lead to physical injury or damage to the stand.



WARNING

When moving Cintiq to a different location, either remove the display unit from the stand (see page 13 for details) and then move both items separately, use the lock screws to fix Cintiq to the stand (see page 56 for details), or hold onto both Cintiq and the stand to make sure that the stand does not separate from the display unit when moving them together.

Before moving Cintiq, first adjust the stand to its full upright position; this will reduce the spring tension so that the stand will not accidentally release and snap shut. If the display unit is in landscape orientation, use one hand to grasp the bottom of the display and with your other hand grasp the back of the stand. Be sure to lift on both the display and the stand so that the stand will not separate from the display when moving Cintiq.

If Cintiq is in portrait orientation or has been locked to the stand with the rotation lock screws (see page 56), the stand will not separate from the display unit and Cintiq can be safely lifted by grasping the display unit with both hands.

Always follow the instructions on page 13 to remove the display unit from the stand.



WARNING

If the LCD screen has been damaged, DO NOT touch any liquid that may be leaking from it; this liquid is an irritant. In case of contact with skin, eyes, or mouth, rinse immediately with running water for at least 15 minutes or more. If contact is made with the eyes or mouth, also consult a physician.



WARNING



– LAMP(S) INSIDE THIS PRODUCT CONTAIN MERCURY AND MUST BE RECYCLED OR DISPOSED OF ACCORDING TO LOCAL, STATE OR FEDERAL LAWS.

The Cintiq pen display has a backlight which contains mercury (Hg).

Be sure to dispose of properly, and to manage any disposal of this unit in accordance with your local ordinances and laws.



WARNING

Do not disassemble the Cintiq stand. Improper disassembly could result in physical injury or damage to the stand. In this case, Wacom shall have no responsibility to repair or replace the product.



WARNING

Prevent children from swallowing the pen tip or side switch. The pen tip or side switch may accidentally be pulled out if children are biting on them.



CAUTION

Do not disassemble the Grip Pen. This may cause the device to malfunction. In this case, Wacom shall have no responsibility to repair or replace the product.



CAUTION

Do not scratch the display screen. Avoid placing sharp objects on the display screen surface.



CAUTION

Avoid intensive shock or vibration to Cintiq, the Cintiq stand, or the Grip Pen. Hitting or dropping Cintiq may damage the display screen or other components.



CAUTION

Do not put heavy articles on the pen display or push against it with a strong force; this may damage the display screen or break the Cintiq stand locking mechanism.



CAUTION

Do not place heavy articles on the Cintiq cabling, repeatedly bend the cables sharply, or apply heavy stress to the cable connectors; this may damage the unit or cabling.



CAUTION

Do not store the pen display tablet on a surface that would excessively bend or crimp the cable.



CAUTION

If the pen tip becomes sharp or angular, it may damage the coating on the display screen. Please replace the pen tip if necessary.



CAUTION

Do not use any organic solvent (e.g., alcohol) or even mild detergent to clean the display screen. Use of these cleaners can damage the coating on the screen. Please note that damage of this kind is not covered by the manufacturer's warranty.

- To clean the display screen, use an anti-static cloth or a slightly damp cloth. When cleaning, apply only a light amount of pressure to the display screen and do not make the surface wet.
- To clean the Cintiq casing, Cintiq stand, or Grip Pen, use a soft cloth with mild detergent (such as dish washing liquid) diluted with water.
- Before cleaning, always disconnect your product from the AC power source.



CAUTION

Do not expose Cintiq to high voltage electrostatic discharges or to a build-up of an electrostatic charge on the LCD screen. This may result in a temporary discoloration and blotching of the display. If discolorations occur, leave the display on and the discolorations should disappear within a few hours.



Reuse, recycling and recovery. You are urged to recycle this product when replacing it with a newer product or when it has outlived its useful life by bringing it to an appropriate collection point for recyclable materials in your community or region. By doing this, you can help improve the environment of your community as well as minimize the potential negative effects created, should any hazardous substance that may possibly be present within waste material reach the environment during the disposal process.

Within the European Union, users are required not to dispose of Waste Electrical and Electronic Equipment (WEEE) as unsorted municipal waste, according to the Directive 2002/96/EC of the European Parliament and of the Council of 27 January 2003, or the corresponding local laws of the Member States. Products for which this is applicable will be marked with the WEEE symbol shown at the beginning of this note unless this is not feasible because of the size or the function of the product. Wacom products are subject to the Directive 2002/96/EC and therefore you should always collect them separately and bring them to the appropriate collection point in your community or region.

Wacom pen display products (Cintiq series) comply with the European Union RoHS Directive 2002/95/EC (RoHS Directive).

CONTENTS







Introduction and overview	1
Precautions on use and handling	2
Physical location	2
Environment	2
Usage	3
Handling	3
Unpacking your Cintiq	8
Package contents	8
Setting up the Cintiq stand	9
Unpacking and mounting the Cintiq pen display	10
Adjusting the display incline	11
Adjusting rotation	12
Using the pen holder	12
Removing Cintiq from the display stand	13
Cintiq pen display components	14
Front view	14
Rear view	15
Installation	16
System requirements	16
Step 1: display installation	17
Display cabling diagram	19
Step 2: pen tablet installation	22
USB cable installation	22
Pen tablet USB cabling diagram	22
Software installation	23
Working with your Cintiq	24
Using the Grip pen	24
Pen components	24
Basic pen operations	25
Tablet controls	27
Using ExpressKeys	28
Using the Touch Strips	29
Setting up your work area	30
Customizing	32
Opening the control panel	32
Learning more about Cintiq	32
Customization basics	33
Calibrating Cintiq	34
Adjusting the display	35
Factory presets, auto-sync, and user settings	35
On Screen Display (OSD) settings	35
Adjusting clock and phase (VGA only)	39
Power saving	40

Troubleshooting	41
Testing Cintiq	41
Testing controls and input tools	43
Testing the ExpressKeys	43
Testing the Touch Strips	43
Testing a pen	44
Display troubleshooting	45
General display problems	45
VGA problems	46
Pen tablet troubleshooting	47
General problems	47
Windows-specific problems	50
Macintosh-specific problems	51
Technical support options	52
Obtaining driver downloads	53
Appendix	54
Caring for Cintiq	54
Cleaning	54
Replacing the pen tip	55
Optional display configurations	56
Using an alternate mount or stand	57
Pen and digital ink capabilities in Windows Vista	60
About the Windows Vista Tablet PC Input Panel	61
Uninstalling Cintiq	62
Product specifications	63
General specifications	63
Display	63
Pen tablet	64
Display stand	64
Power adapter	64
Grip pen (model ZP-501E)	64
Accessories	65
Ordering parts and accessories	66
Radio and television interference	67
Federal Communications Commission (FCC) notice	67
Industry Canada (Canada only)	68
CE declaration	68
Warranty (Worldwide, Except for Europe, Africa and Middle East)	69

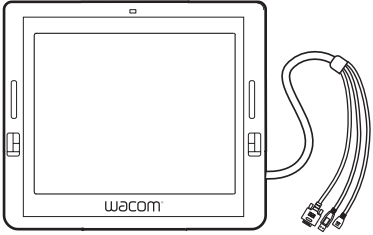
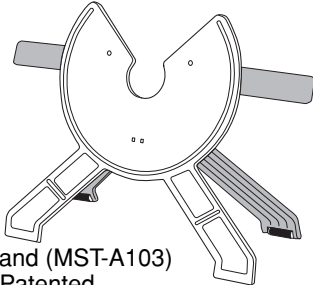
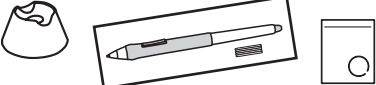
UNPACKING YOUR CINTIQ

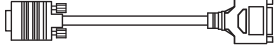
PACKAGE CONTENTS

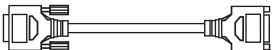
You will find the product parts and accessories packed together in the accessories box. **To avoid damaging your product, please review the instructions on the following pages before setting up or using Cintiq or the Cintiq stand.** Your product came with the following items:

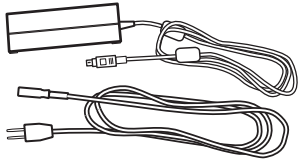
 <p>Cintiq 21UX pen display, main unit with attached cable</p>	 <p>Cintiq stand (MST-A103) *Patented</p>
Parts and accessories	
 <p>Grip Pen with replacement nibs, pen stand, and nib removal set (ZP-501E, PST-A034, and FUZ-A131)</p>	 <p>Rotation lock screws (qty 2) (MNE-059)</p>
 <p>Installation Guide & Hardware Manual (this manual)</p>	 <p>VGA to DVI-I adapter (STJ-A262)</p>
 <p>Wacom Pen Tablet Driver CD (contains the driver software)</p>	 <p>DVI-D to DVI-I adapter (STJ-A263)</p>  <p>Bearing hub recess cover plate and screws (PPL-A155)</p>  <p>Power supply (POW-A098) and power cable</p>

Note: Images not shown to scale. Some package configurations may include additional CDs or DVDs containing application software. To install these applications, review the instructions that came with those CDs or DVDs. Retain the package box for use when storing or shipping Cintiq.

Next step: Set up the Cintiq stand. See page 9.

SETTING UP THE CINTIQ STAND

Place the stand on your desktop or work surface, making sure the stand is stable and will not tip or fall when the pen display is mounted on it. Then familiarize yourself with the stand components.

⚠ WARNING Do not operate the incline adjustment levers when Cintiq is not mounted on the stand, and do not lift the stand by the adjustment levers; the stand is spring-loaded and may cause injury or damage if released without the weight of Cintiq on the stand. Improper operation may lead to physical injury or damage to the stand. Be careful to avoid catching your finger in the gap of the movable portion of the stand.

Incline adjustment levers

When Cintiq is mounted on the stand, use these levers to adjust the display incline, as described in *Adjusting the display incline* on page 11.

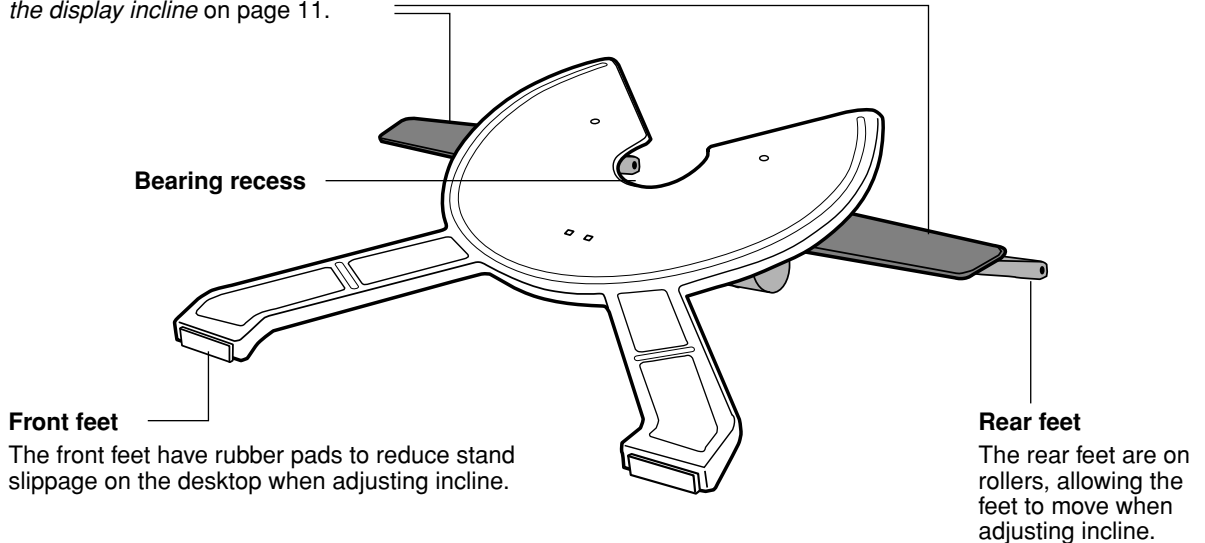

Next step: Unpack the pen display and mount it on the Cintiq stand. See page 10.

UNPACKING AND MOUNTING THE CINTIQ PEN DISPLAY

Remove any packing materials from the back of the display unit and cabling.

To mount Cintiq on the stand:

- Make sure the stand is stable on your desktop or other work surface and will not tip or fall when Cintiq is mounted on it. Securely grasp Cintiq with both hands so that the display faces toward you, with the power switch and LEDs located at the top.

Align Cintiq parallel to the front of the stand so that the bearing hub is located between the V-shaped upper edges of the stand's bearing recess. See **- A -** (The V-shaped edges of the stand will serve as a guide for positioning the bearing hub.)

- With the back of Cintiq resting against the stand, lower Cintiq until the bearing hub rests securely in the bearing recess of the stand. See **- B -** on the following page. The display unit will be held in place by gravity; there will be no audible 'snap' that indicates a mechanical lock.

Note: If you do not need to rotate the Cintiq pen display, you may want to secure it to the stand with the rotation lock screws. For information on this, see *Optional display configurations* on page 56. To learn about other mounting options, see *Using an alternate mount or stand* on page 57.

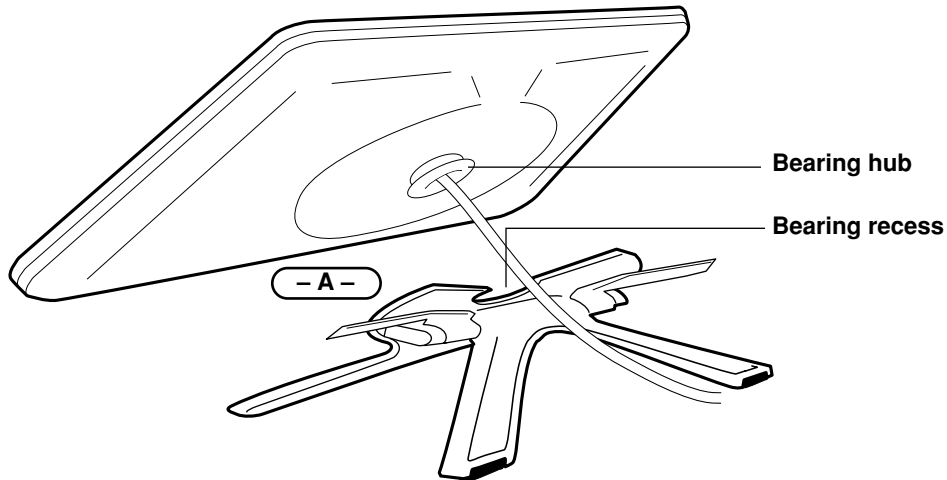

WARNING When operating the incline adjustment levers, Cintiq must be mounted on the stand with the stand feet resting on a stable, flat surface. The stand is spring-loaded and can snap back quickly, causing injury or damage if not operated properly.

After the display unit has been mounted on the stand, remove the foam blocks that lock the adjustment levers in place. Save these blocks with the other packaging materials; you will need them if in the future you want to ship Cintiq.

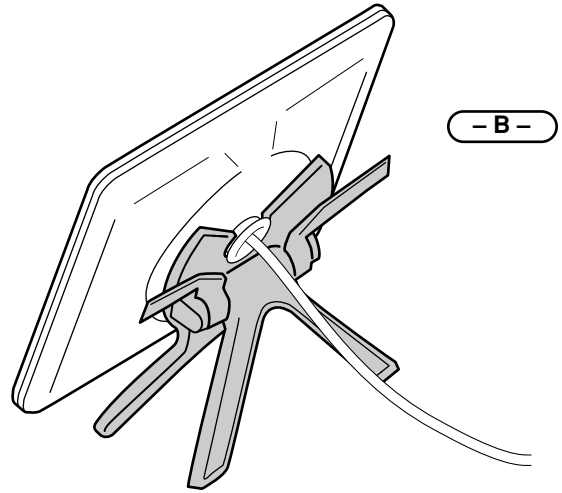

ADJUSTING THE DISPLAY INCLINE

To adjust the display incline, face the front of the Cintiq pen display and grasp it on the left and right side at approximately the same height as the Cintiq stand adjustment levers. Use your fingertips to gently pull the incline adjustment levers toward the display unit; this will release the stand's clutch mechanism. Tilt the display to adjust the incline setting.

- To lower Cintiq, pull the left incline adjustment lever toward Cintiq and gently lower Cintiq to the desired incline angle. Release the lever to lock the stand in place.
- To raise Cintiq, pull the right incline adjustment lever toward Cintiq and gently raise Cintiq to the desired incline angle. Release the lever to lock the stand in place.

Note: The stand adjustment levers exhibit some natural play before the clutch mechanism engages. When adjusting the stand incline, set it slightly higher than you plan to work with, then lower the display to the desired position.

WARNING Before moving Cintiq, first adjust the stand to its full upright position; this will reduce the spring tension so that the stand will not accidentally release and snap shut. If the display unit is in landscape orientation, use one hand to grasp the bottom of the display and with your other hand grasp the back of the stand. Be sure to lift on both the display and the stand so that the stand will not separate from the display when moving Cintiq. If Cintiq is in portrait orientation or has been locked to the stand with the rotation lock screws (see page 56 for details), the stand will not separate from the display unit and Cintiq can be safely lifted by grasping the display unit with both hands.

ADJUSTING ROTATION

The pen display can be rotated on the display stand when the incline is less than or equal to 25 degrees.

To adjust rotation, grasp Cintiq by the main body and rotate the unit to the desired position; it will move on the bearing hub. You can only rotate the display unit 180 degrees in either direction. If you do not plan to rotate the Cintiq, use the rotation lock screws to fasten the display to the stand in a horizontal position. See *Optional display configurations* on page 56 for more information.

USING THE PEN HOLDER

The integrated pen holder is located at the back of the pen display tablet.

Note: The pen holder is not available for use when routing the cable to exit through the top cable opening.

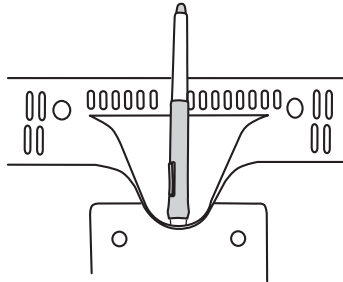

Next step: Go to page 14 and familiarize yourself with the pen display.

REMOVING CINTIQ FROM THE DISPLAY STAND

To remove Cintiq from the display stand:

- If the rotation lock screws are attached, remove them from the back of Cintiq.
- Position the pen display to landscape orientation before removing it from the display stand. The stand will not release unless Cintiq is in landscape orientation.
- Next, raise the stand incline to the highest position. See *Adjusting the display incline* on page 11 for instructions.
- Firmly grasp the pen display on both the left and right sides of the body, and lift the unit out of the display stand.

Important: When removing Cintiq from the display stand, always lift Cintiq in a direction parallel to the front of the stand. You may also need to rotate Cintiq slightly so the stand will release.

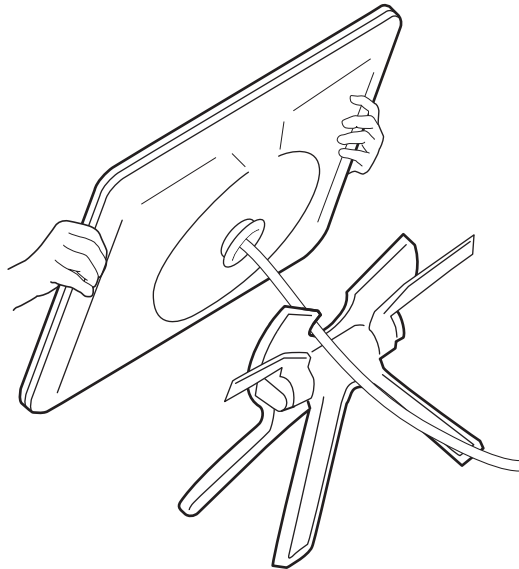

Note: When packing Cintiq for transport, first adjust the stand to its lowest position and place the foam packing blocks under the incline adjustment levers before removing Cintiq from the stand. The foam blocks will keep the stand from snapping shut while in its packaging. Always pack Cintiq and its stand in their original containers and protective cushions. Never pack Cintiq while it is mounted on the stand; this may damage the unit or stand during transportation.

CINTIQ PEN DISPLAY COMPONENTS

After the Cintiq pen display is safely mounted on the Cintiq stand, take some time to familiarize yourself with its features and components.

The display and tablet sensor function as an integrated output and input device. The display supports resolutions up to 1600 x 1200 pixels at 16.77 million colors. The tablet sensor reports pen coordinates, pressure, tilt, switch, eraser, and other information.

FRONT VIEW

Status LED

Lights blue when the pen is in the active area of the pen display tablet and the pen tip, eraser, or side switch are pressed. The USB cable connector must be plugged into an active USB port and a video signal must be present before the LED will light.

Power LED

Lights blue when power has been supplied to Cintiq and a video signal is present.

Glows orange when no video signal is detected by Cintiq. (e.g., Your computer is turned off, starting up, or has entered a power management mode in which video signals are not sent.)

Power switch

Turns power on or off.

Touch Strip

Touch Strip

Slide your finger over the Touch Strips to zoom, scroll, or perform custom keystroke actions. See *Tablet controls* on page 27.

ExpressKeys

These customizable keys simulate modifier keys, keystrokes, and other frequently used functions. A display toggle function is also available, enabling you to toggle the screen cursor between the Cintiq pen display and your other displays. See page 27.

ExpressKeys

Integrated display and tablet

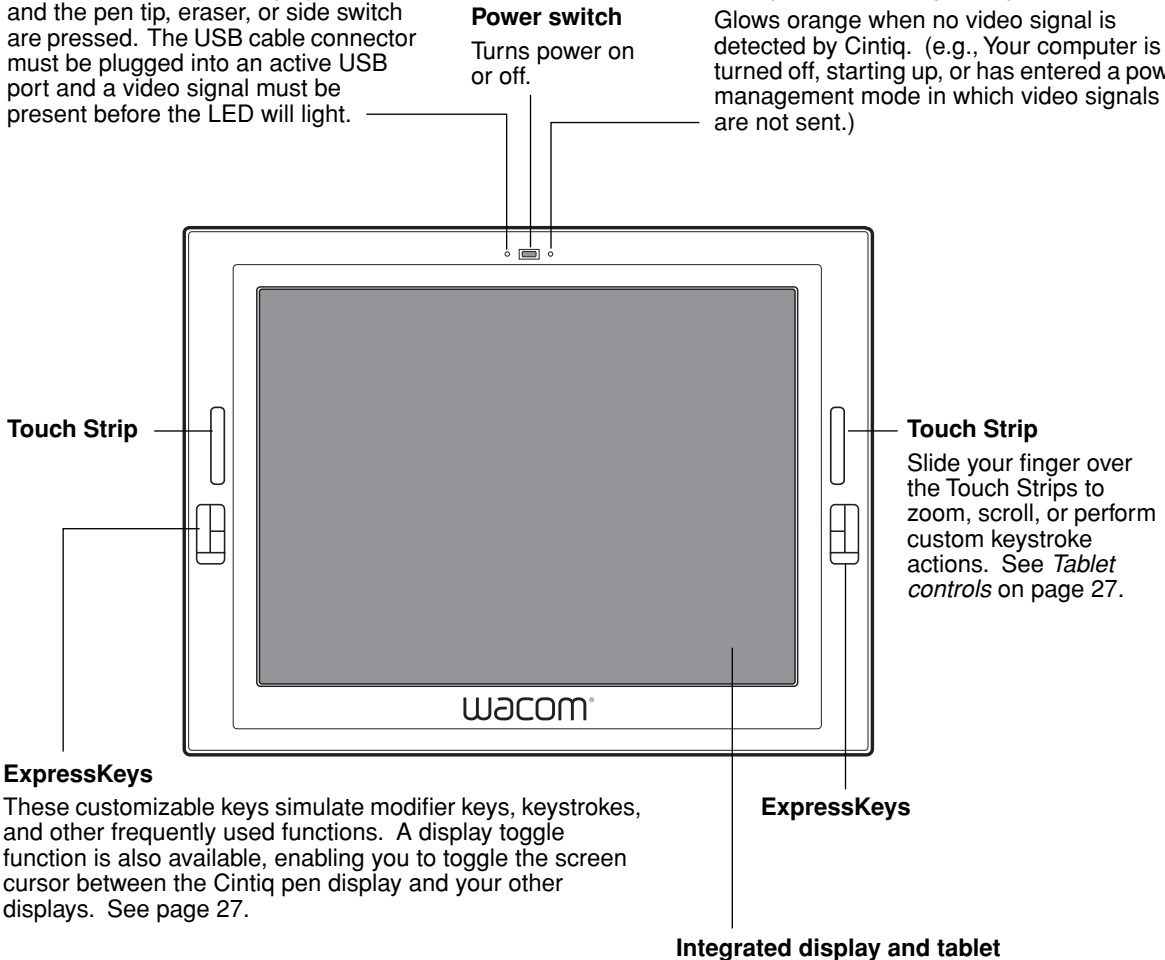

REAR VIEW

Digital/Analog (DVI/VGA) switch

Set this switch for the video connection you will be using.

On Screen Display (OSD) controls

Use these controls to adjust a variety of display settings. See *Adjusting the display* on page 35.

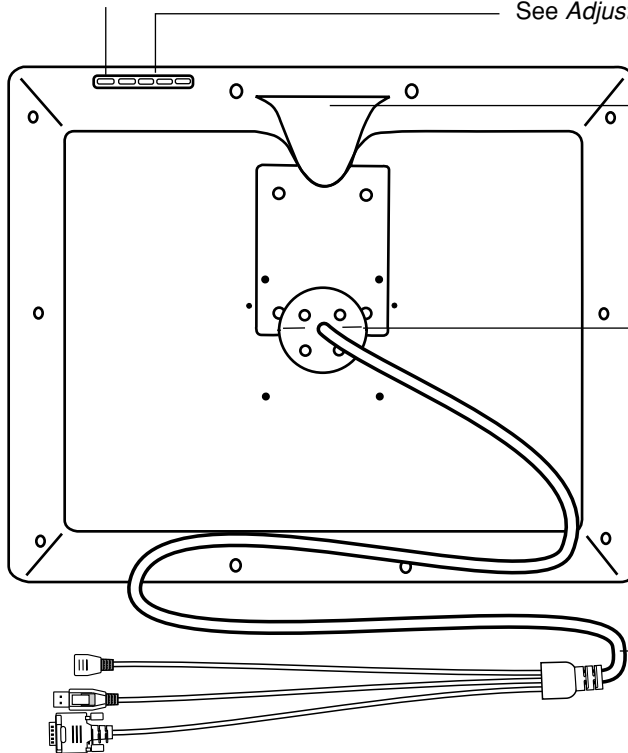

Integrated pen holder and alternate cable exit

The pen can be stored here. If you are not using the Cintiq stand supplied with the unit, you can route the cable to exit from this location. See *Using an alternate mount or stand* on page 57.

Bearing hub

Fits into the bearing recess on the Cintiq stand. Allows rotation of Cintiq, and easy mounting and removal from the stand.

Cabling and connectors

The connectors on the integrated cable are for DVI-I video, USB data, and power.

Important: Always store the pen display on the Cintiq display stand or in its original packing carton when not in use. Do not store the display unit on a surface that would excessively bend or crimp the cable.

Next step: *Installation.* See page 16.

INSTALLATION

SYSTEM REQUIREMENTS

Before installing Cintiq, make sure your computer meets the following minimum system requirements:

- **PC.** Windows Vista™, Vista x64, XP, XP x64, or 2000. DVI or VGA video connector, available USB port, and CD-ROM drive.
- **Macintosh.** OS X, v10.3.9 or greater. DVI or VGA video connector, available USB port, and CD-ROM drive. ADC connectors require an ADC to DVI-I adapter, not included.

Cintiq supports both digital (DVI) and analog (VGA) video signals. If updating your video card, complete the video card hardware and software installation before connecting Cintiq. If you have another display that is compatible with your video card, you can connect that display to the card in order to verify the video card is operating correctly.

Using the VGA to DVI-I adapter, you can connect Cintiq to a VGA video card. However, connecting Cintiq to a DVI video card generally results in optimum performance.

Notes: Cintiq can be used alone or with another display, such as a CRT monitor or LCD projector. To use Cintiq with another display, you will need two video cards or a video card with dual output.

Depending on the capabilities of your video card and operating system, you may be able to set up Cintiq as a mirrored, extended, or independent display. Refer to your video card documentation for more information on its capabilities.

When you are working with more than one display, Cintiq will map to the displays based upon how your system is configured. By default, if you are in mirror mode, the pen tablet will map to the entire space on each display. Please refer to your hardware and operating system documentation for details on configuring your computer and operating system for use with multiple displays.

A display toggle function is available for use with multiple display systems. This enables you to toggle the screen cursor between the Cintiq pen display and your other displays. For more information, see *Using ExpressKeys* on page 28.

There are two primary steps to the installation process:

- **Step 1: display installation**
- **Step 2: pen tablet installation**

Follow ALL installation instructions carefully.

STEP 1: DISPLAY INSTALLATION

In this step, Cintiq is installed as a display on your system.

Important: Do not connect the USB data cable until instructed to do so.

- Turn off your computer.

Caution: Never connect or disconnect the video or power cables while your computer or Cintiq are powered on – this can damage the display or video card.

- If your computer has only one video connector, you will need to unplug your previous display. Determine if your computer has a digital (DVI) or analog (VGA) connector, and set the DVI/VGA switch located on the back of Cintiq for the video connection you are using. Move the switch toward the tablet edge for Digital (DVI-I or DVI-D), and move it toward the OSD buttons for ANALOG (VGA). See – **A** – in the connection diagram on page 19.
- Making sure to tighten the thumbscrews on the connectors, follow the instructions below for your video connector. See – **B** –

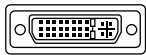

DVI-I connector

For DVI-I operation, plug the Cintiq video cable into the DVI-I connector of your video card.

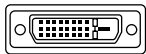

DVI-D connector

For DVI-D operation, plug the Cintiq video cable into the DVI-D to DVI-I adapter supplied with Cintiq, and then plug the adapter into the DVI-D connector on your video card.

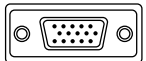

VGA connector

For VGA operation, plug the Cintiq video cable into the VGA to DVI-I adapter supplied with Cintiq, and then plug the adapter into the VGA connector on your video card.

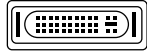

Apple ADC
connector



Mini-VGA port

If connecting to an Apple ADC or mini-VGA connection, you will need to obtain an appropriate adapter. Adapters can be purchased at various retail outlets.

For ADC operation, plug the Cintiq video cable into the ADC to DVI-I adapter. Then plug the ADC adapter end into the ADC connector on your video card.

For an Apple mini-VGA connector, plug the Cintiq video cable into the VGA to DVI-I adapter (supplied with Cintiq). Plug the mini-VGA adapter into the computer's mini-VGA port. Then plug the male and female VGA connectors together.

-
- Connect the power adapter to Cintiq. See – **C** – on the next page.
 - Then connect the adapter's power cable and plug the adapter into an AC outlet. See – **D** –
 - Turn on Cintiq. The power LED will light orange.

DISPLAY CABLING DIAGRAM

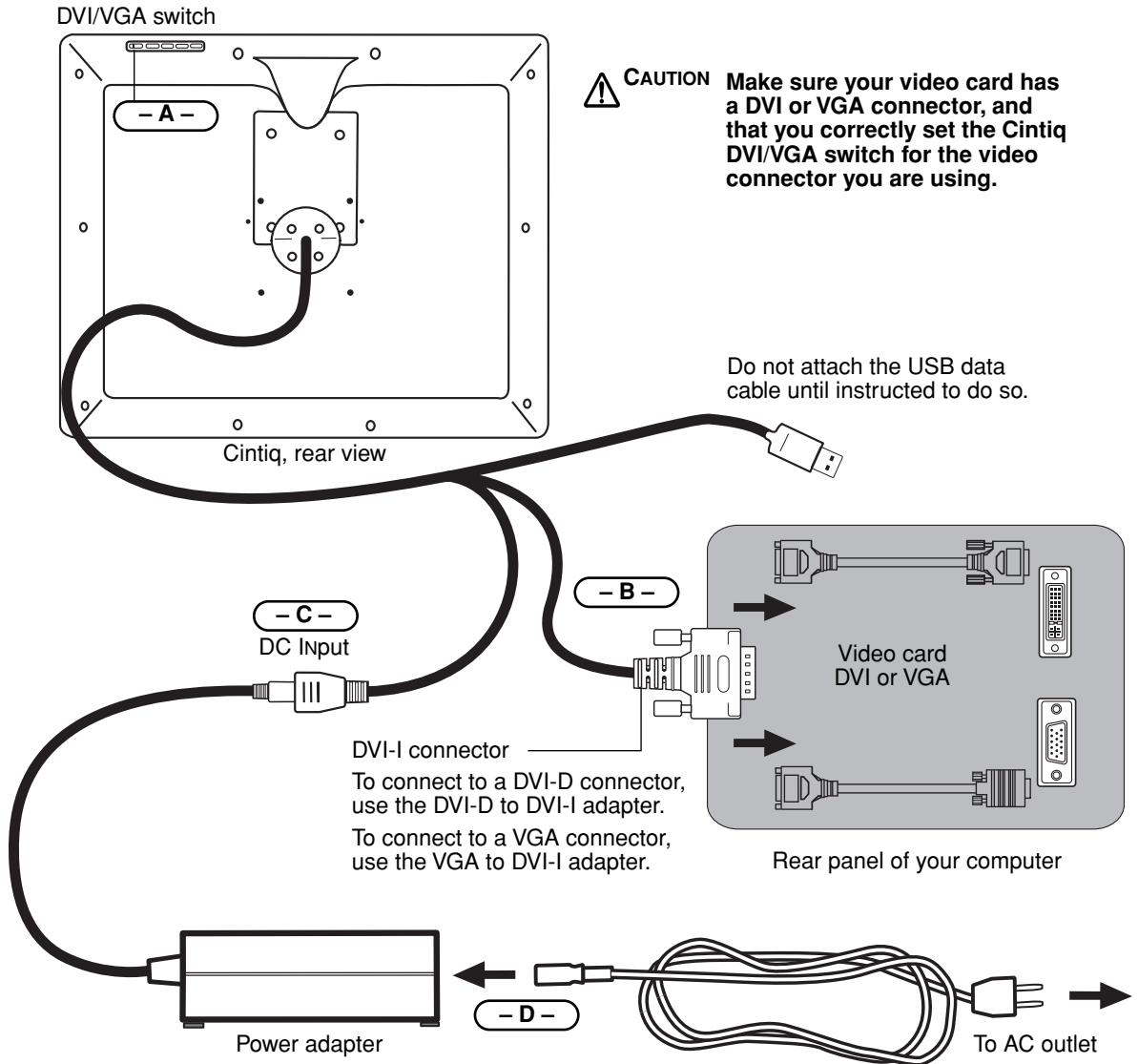

- CAUTION** Use only the power adapter that came with Cintiq; use of an improper power adapter may damage the unit.
- Do not connect or disconnect the video or power cables while Cintiq or your computer are turned on** – this can damage the display or computer video card.
- Make sure that the display refresh rate does not exceed 85 Hz (60 Hz for UXGA).**

- Next, turn on your computer.

For Windows systems, Cintiq will automatically install as a default display. If you want Cintiq to be identified as a Cintiq display and if you want to install the color calibration profile for Cintiq, follow the instructions below to update the display driver for Cintiq:

1. Open the CONTROL PANEL folder.
 - For Windows Vista, under APPEARANCE AND PERSONALIZATION select ADJUST SCREEN RESOLUTION.
 - For other Windows versions, open the DISPLAY PROPERTIES control panel and select the SETTINGS tab.
Note: If you have more than one display and you need help in determining which display corresponds to Cintiq, click the IDENTIFY monitors button. Select the display for Cintiq.
2. Click the ADVANCED settings button.
3. Select the MONITOR tab and click the PROPERTIES button.
4. Select the DRIVER tab and click the UPDATE DRIVER... button. An update driver dialog or Wizard will appear.
5. Insert the Wacom Pen Tablet Driver CD. If the Wacom Tablet installation menu displays, close it.

Windows Vista:

- Select the option BROWSE MY COMPUTER FOR DRIVER SOFTWARE.
- Enter the drive letter for the Wacom Pen Tablet Driver CD and click NEXT.
- After the installation is complete, close any open control panel windows.

Windows XP:

- The Wizard will ask if Windows can search for software. Choose NO, NOT THIS TIME and click NEXT.
- Select the option INSTALL FROM A LIST OR SPECIFIC LOCATION (ADVANCED), and click NEXT.
- Select the option DON'T SEARCH. I WILL CHOOSE THE DRIVER TO INSTALL and click NEXT.
- Select the Cintiq pen display option and then click the HAVE DISK... button. Enter the letter of your CD-ROM drive (e.g., E:\), and click OK.
- Follow the prompts to continue. (If the HARDWARE INSTALLATION dialog box displays, click CONTINUE ANYWAY to accept the driver.) After the installation is complete, click the FINISH button and close any open control panel windows.

Windows 2000:

- Follow the prompts selecting the default options.
- If a signing warning dialog box displays, click YES to accept the driver. After the installation is complete click the FINISH button to close the Wizard and then close the DISPLAY PROPERTIES control panel.

For Macintosh systems, a Cintiq color profile will be added to your computer's color management system during the tablet software driver installation process. To activate this color profile for use with Cintiq, you may need to select the Cintiq 21UX profile in the system's ColorSync Utility control panel. For more details, see the color management information in your operating system and application documentation.

- As necessary, configure the display control panel settings for the proper size and color resolution. The maximum (native) resolution of the Cintiq 21UX is 1600 x 1200 pixels with 24 bit color. The display size and color resolution may be constrained by the capabilities of your video card. See the video card manufacturer's documentation for details.

For Windows: If you are using Cintiq as a secondary display, you may first need to enable Cintiq in your Display Properties control panel.

- If using analog (VGA) mode, you may want to fine-tune the display. See *Adjusting clock and phase (VGA only)* on page 39 and *Adjusting the display* beginning on page 35.
- After the display portion of Cintiq is working to your satisfaction, move on to *Step 2: pen tablet installation* to install the pen tablet portion of Cintiq. For troubleshooting tips, see page 41.

Notes:

Each Cintiq LCD panel is produced under stringent quality standards. Production techniques cannot guarantee an absolutely perfect TFT display, and some panels may exhibit a certain number of pixels that show an incorrect color. See the specifications on page 63 for more information.

If an image has fine striping (such as screen stripes), it may appear to flicker or display a moiré pattern.

Do not apply excessive pressure on the display surface, it may cause the appearance of a moiré or pooling pattern. If this occurs, use less pressure on the display screen when working with the pen.

When a still image is displayed for a long period of time, an after-image may remain for a short time. To prevent this, Wacom recommends using a screen saver or other power management feature.

Important: To extend the life of the backlight, set your computer's power management to turn off the display when it is not in use for extended periods of time.

STEP 2: PEN TABLET INSTALLATION

USB CABLE INSTALLATION

Plug the USB connector into an available USB port on your computer or into a USB hub attached to your computer. See – E – in the connection diagram below.

Next, move on to the pen tablet *Software installation* on page 23.

PEN TABLET USB CABLING DIAGRAM

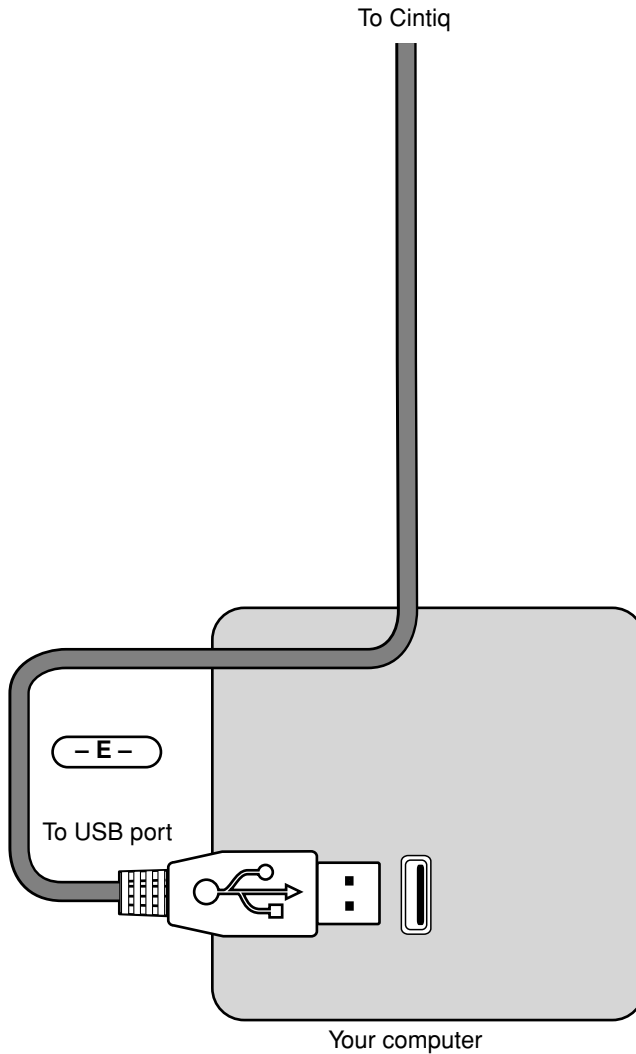

SOFTWARE INSTALLATION

IMPORTANT: You MUST install the Wacom pen tablet driver software for correct pen-on-screen functionality.

To install the tablet software:

- Save your work and close all open applications. Temporarily disable any virus protection programs.
- Insert the Wacom Pen Tablet Driver CD into your computer's CD-ROM drive. If the software installer menu does not automatically display, double-click on the INSTALL icon located on the CD.
- Click on the INSTALL TABLET link and follow the prompts to install the driver software.
- Reactivate your virus protection program.
- After completing the software installation, make sure you can use your pen on the Cintiq display to move the screen cursor.

When you place the pen tip on the display screen, the screen cursor should immediately jump to a corresponding position approximately beneath the pen tip. Lift the pen tip and place it on the display screen surface in a different location – the screen cursor should again jump to the new position. This is known as absolute positioning, and enables you to position the screen cursor without having to drag your pen across the display screen surface.

- Be sure to check the Read Me file for updated information. If you have trouble installing Cintiq, see the *Troubleshooting* section beginning on page 41.

Notes:

For Windows Vista, driver installation automatically activates the new pen input functions available within Windows Vista and Office 2007 (except for Windows Vista Home Basic).

For Windows Vista, XP, and Macintosh OS X, user-specific preferences are supported. After logging in, each user can customize their personal settings in the Wacom Tablet control panel. Switching to another user will automatically load the settings for that user.

To uninstall the tablet driver, see *Uninstalling Cintiq* on page 62.

Next steps:

Adjust the pen display tablet calibration to precisely align the screen cursor to the pen tip. See *Calibrating Cintiq* on page 34.

To learn more about using Cintiq, proceed to *Working with your Cintiq* on page 24.

WORKING WITH YOUR CINTIQ

USING THE GRIP PEN

As you work with Cintiq, you can rest your hand lightly on the display screen, just as if it were a drawing board or sheet of paper. The pen is cordless, battery-free, and senses the amount of tilt and pressure you exert upon it. Hold the Grip Pen as you would a normal pen or pencil. Make sure the DuoSwitch is in a convenient location where you can toggle it with your thumb or forefinger, but not accidentally press it while drawing. You can tilt the pen in any way that feels most comfortable for drawing.

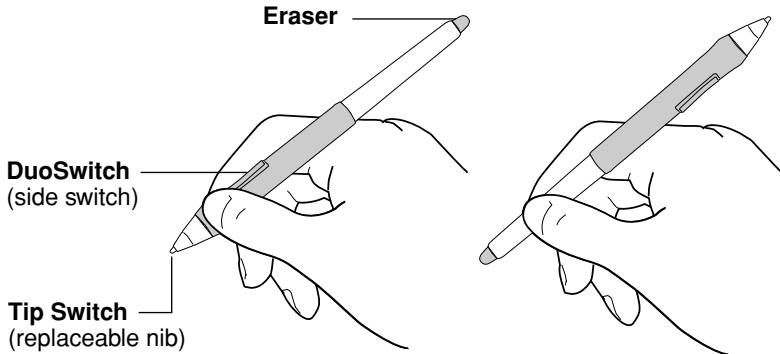

Note: When the Grip Pen is not in use, place it in the pen stand, the pen holder, or lay it flat on your desk.

To maintain the sensitivity of your pen, do not store the pen in a container where it will rest on its tip or eraser.

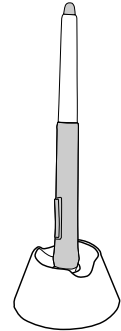

PEN COMPONENTS

The components of your Cintiq Grip Pen function in the following manner:

Pen tip: The pen is activated as soon as it is brought within 5 mm (0.2 inch) of the pen display screen. This allows you to position the screen cursor without touching the pen tip to the display screen. When pressure is applied to the pen tip, the tip switch is turned on and the pen simulates a primary mouse button click. The tip click pressure can be adjusted in the Wacom Tablet control panel.

DuoSwitch: The DuoSwitch is programmable, and can be used to perform the same click and double-click functions as the tip switch. Toggle the DuoSwitch in either direction to activate the upper or lower button functions. You can use the DuoSwitch whenever the pen tip is within 5 mm (0.2 inch) of the tablet surface; you do not need to touch the pen tip to the tablet in order to use the switch. By default, the upper switch is set to DOUBLE CLICK and the lower switch is set to RIGHT CLICK.

Eraser: When the eraser is brought within 5 mm (0.2 inch) of the display the tablet reports the pen location. Pressure information is reported as you press down on the eraser. By default, the eraser function is set to ERASE.

Important: Only use a pen that is compatible with Cintiq, such as the pen that shipped with the unit, or any of the pens from the Intuos3 product line (see *Accessories* on page 65). Other pens may not function properly. Also, the Cintiq pen tip is specifically designed for use with the Cintiq pen display – the tips on other pens could damage the protective coating on the Cintiq display screen.

Refer to *Customizing* on page 32 and to the electronic Software User's Manual for information on customizing the pen settings.

BASIC PEN OPERATIONS

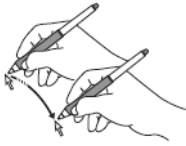

Pointing and selecting: Move the pen slightly above the Cintiq display screen to position the screen cursor; you do not need to touch the tablet surface to move the screen cursor. The cursor jumps to the location where you place the pen. Press the pen tip on the display screen to make a selection.

Note: You must calibrate the pen display tablet to correctly align the screen cursor with the pen tip. (See *Calibrating Cintiq* on page 34.) If the screen cursor does not jump to a position close to the pen tip when you place the pen on the display screen, then the pen tablet driver may not be installed or is not loading. Install the pen tablet driver software if necessary. Otherwise, refer to *Troubleshooting*, beginning on page 41.



Clicking: Tap the display screen once with the pen tip, or touch the pen to the display screen with enough pressure to register a click.

Windows tip: To make navigating with the pen easier, configure Windows to select when the pen is over an icon and to launch the icon with a single click. To turn on this feature, first open a folder.

For Windows Vista, from the ORGANIZE pull-down menu choose FOLDER AND SEARCH OPTIONS. From the GENERAL tab select SINGLE-CLICK TO OPEN AN ITEM (POINT TO SELECT).

For other Windows versions, from the TOOLS pull-down menu choose FOLDER OPTIONS.... From the GENERAL tab select SINGLE-CLICK TO OPEN AN ITEM (POINT TO SELECT).



Double-clicking: Press the upper side switch, or quickly tap the display screen twice in the same place with the pen tip. Double-clicking is easier when the pen is perpendicular to the tablet screen. To fine-tune the double-click area, refer to the electronic Software User's Manual.

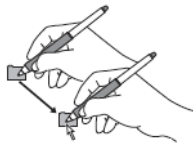

Dragging: Select an object, then slide the pen tip across the display screen to move the object.

Using the side switch: The pen is equipped with a DuoSwitch. This switch has two programmable functions that can be selected by rocking the switch in either direction. You can use the DuoSwitch whenever the pen tip is within 5 mm (0.2 inch) of the tablet surface; you do not need to touch the pen tip to the tablet in order to use the switch. By default, the upper switch is set to DOUBLE CLICK, and the lower switch is set to RIGHT CLICK.

Drawing and writing with pressure sensitivity: The pen responds to the nuance and inflection of your hand movements, enabling you to create natural-looking pen and brush strokes within applications that support this feature. To draw and write with pressure, select a pressure-sensitive tool from your application's tool palette. As you work on the screen surface, use various amounts of downward pressure on the tip of the pen. Press lightly for thin lines or softer color. Press harder for thick lines or dense color.

Drawing with tilt: The pen display tablet recognizes when you tilt the pen from vertical to incline positions. In supporting applications, tilt can be used to control line shape and thickness.



Erasing: In supporting applications, the pen's eraser works like the eraser on a pencil. In text applications, use the eraser to select text, then lift the eraser from the tablet to delete the text.

TABLET CONTROLS

To speed up your workflow in graphics or other applications, your Cintiq pen display features ExpressKeys and Touch Strips. While using the pen with your dominant hand, you can simultaneously use your other hand to operate the ExpressKeys or Touch Strip.

Touch Strip

Slide your finger over the Touch Strip to zoom, scroll, or issue an assigned keystroke function. By default, the Touch Strips enable you to zoom in most graphics applications and to scroll in other applications. You can also set them to issue custom keystrokes. For example, you might set a Touch Strip function to change brush sizes when working in Photoshop. See *Using the Touch Strips* on page 29.

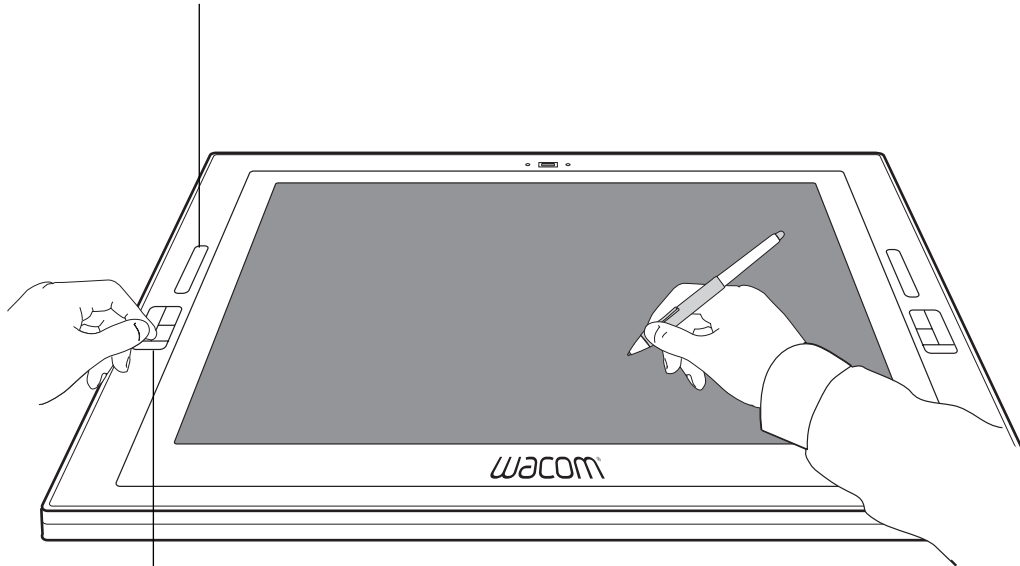

ExpressKeys

Press the customizable ExpressKeys to perform frequently used functions or keystrokes. By default, the keys emulate keyboard modifier keys. In Photoshop, this provides quick access to the grabber hand and alternate tools.

A display toggle function is also available for use on multiple monitor systems. This feature allows you to use your pen on the Cintiq pen display to navigate the screen cursor to any display on your system.

See *Using ExpressKeys* on page 28.

USING EXPRESSKEYS

As you work with your pen on the display tablet surface, press an ExpressKey to toggle between tools or change tool properties. You can work with the default settings, or choose from any of the other available functions. The default settings were chosen to optimize your workflow in Photoshop and other graphics applications, using the following modifier functions:

Button 1: CTRL modifier key for Windows. COMMAND (Apple key) for Macintosh.

Button 2: SHIFT modifier key.

Button 3: ALT modifier key for Windows. OPTION modifier key for Macintosh.

Button 4: SPACE key (spacebar).

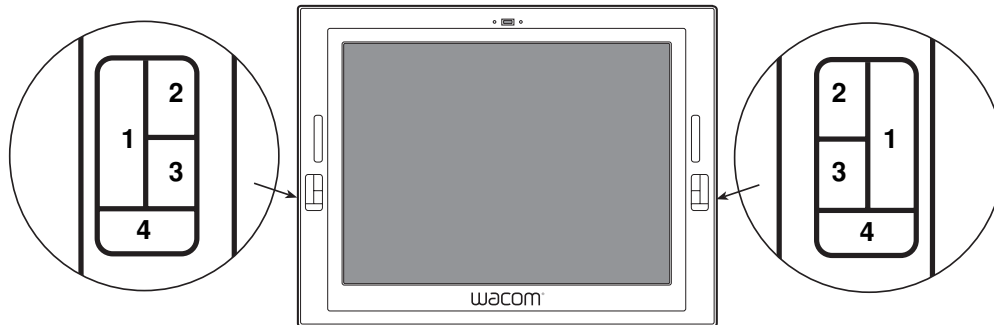

The ExpressKeys are chordable. For example, pressing keys 3 and 1 together simulates ALT+CTRL in Windows, or OPTION+COMMAND on Macintosh systems.

Tips:

- In Photoshop, pressing the spacebar (key 4 on your display tablet) switches the currently selected tool to the hand tool and lets you pan (move) the image within the application window.
- In Photoshop and many other graphics applications, the ALT, CTRL, and SHIFT modifier keys modify a tool or switch to a complementary tool while the modifier key is pressed.

The ExpressKeys are fully customizable, enabling you to make the best possible use of them. Here are a few ideas on how you can use the ExpressKeys:

- Set a pair of keys to commonly used keystrokes, such as [and] to decrease and increase your brush size in Photoshop.
- Set a key to a commonly used keyboard shortcut in order to open files or start an application.
- If you prefer not to (or cannot) use the side switches on your Grip Pen, then set a key to right- or double-click.
- Choose from any of the other available functions.
- On multiple display systems only, set an ExpressKey or pen switch to DISPLAY TOGGLE. You can then press that button to toggle the screen cursor between Cintiq and your other displays.

See the electronic Software User's Manual for more details on the available key settings.

USING THE TOUCH STRIPS

Slide your finger over the Touch Strip to quickly zoom in or out, scroll up or down, or perform other functions with your secondary hand while using your primary hand to work with the Grip Pen. You can also set each Touch Strip to issue custom keystrokes. For example, you might set a Touch Strip action to cycle through layers when working in Photoshop. The Touch Strips can be operated in three different ways:

- **Standard operation:** Slide your finger up or down to zoom, scroll, or issue the assigned keystroke function.
- **Continuous operation:** Press and hold your finger at either end of the Touch Strip to continuously scroll. This is useful for scrolling through long documents or web pages.
- **Single step operation:** Press and release your finger at either end of the Touch Strip to zoom, scroll, or issue the assigned keystroke function one step at a time.

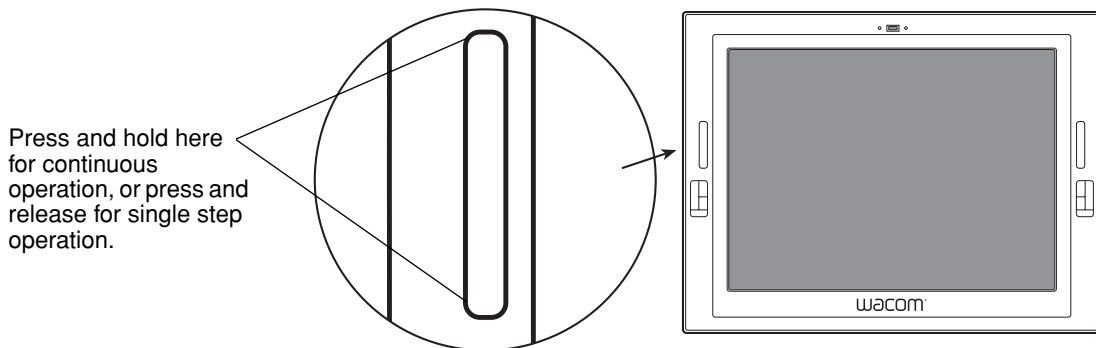

By default, the Touch Strips enable you to zoom in most graphics applications and to scroll in other applications. Each Touch Strip can be independently customized to meet your needs.

Note that the Touch Strips are quite sensitive. If you find yourself accidentally activating a Touch Strip with your drawing arm, open the Wacom Tablet control panel and disable the Touch Strip on your drawing arm side.

Tip: Photoshop users who frequently change brush sizes may want to assign the [and] keys to a Touch Strip. Sliding your finger up or down the Touch Strip will then change the brush size without the need to reach for the keyboard or access the Photoshop BRUSHES palette.

Refer to the electronic Software User's Manual for detailed information on customizing the way your display tablet Touch Strips work.

SETTING UP YOUR WORK AREA

The Cintiq 21UX pen display and stand were designed to provide you with the widest possible range of flexibility and ergonomic work approach. The design allows you to quickly adjust Cintiq to a different position whenever the need arises. You may want to experiment with different height adjustments to determine which best fits your particular working style and tasks.

As you work with Cintiq, you can rest your hand lightly on the display screen, just as if it were a drawing board or sheet of paper.

To minimize fatigue, organize your work area so you can work comfortably. Position Cintiq, the Grip Pen, and your keyboard so they are easily accessible without unnecessary reaching. The pen display tablet and any other displays should be positioned so you can view them comfortably with a minimum of eyestrain.

Here are some other points to keep in mind:

- Take short breaks between tasks to stretch and relax your muscles.
- Use a gentle grip when working with the pen.
- Alternate tasks throughout the day.
- Maintain a good posture at all times. Minimize awkward postures and repetitive movements that cause discomfort. Change your position if you feel any discomfort due to your work position.
- Alternate between different modes of use.

Note: Wacom makes no representation, promise or guarantee that Wacom products will cure or prevent, in whole or in part, mouse-induced repetitive stress symptoms, injuries or conditions. Individual results may vary. Always obtain competent medical advice to determine the most appropriate treatment for your specific situation.



By adjusting the Cintiq stand to its lowest position, the pen display unit can be freely rotated on the display stand without touching the desktop. In this position, Cintiq emulates a traditional animator's table and gives you the freedom to rotate the display unit to any angle for the greatest comfort and accuracy of stroke while drawing or editing images.



Adjusting the Cintiq stand to its highest position is common when your work requires a large amount of keyboard input. This position is also useful when presenting your work to co-workers or clients.

Hints:

- If the rotation lock screws are attached to the back of Cintiq, they must be removed before Cintiq can be rotated.
- Before rotating the display unit, be sure the cable is freely rotating behind the unit.
- Because the Cintiq drawing surface will be a little higher than your desk, consider adjusting the height of your desk or chair to assure comfortable use of the device.
- Do not pull the cable out of its computer connections by accidentally moving the pen display tablet too far from the computer.

Note: Cintiq can also be mounted to articulated arms or other third-party stands meeting the VESA 100 specification for monitor stands. See *Using an alternate mount or stand* on page 57 for details.

Next step: If you have not already done so, learn about the basics of customizing the Grip Pen. See *Customizing* on page 32.

CUSTOMIZING

After you master the basics of using your Grip Pen on the Cintiq pen display, you may want to customize the way the pen or pen display works. The Wacom Tablet control panel makes it easy to customize Cintiq and the pen.

OPENING THE CONTROL PANEL

To open the control panel, use the Cintiq pen on the pen display tablet:

Windows. Click on the Windows START button and choose ALL PROGRAMS. (For Windows 2000, choose the PROGRAMS group.) Then select WACOM TABLET and choose the WACOM TABLET PROPERTIES option.

Macintosh. Open SYSTEM PREFERENCES from either the Dock, the Apple menu, or from the APPLICATIONS folder. Then click on the WACOM TABLET icon.

After opening the control panel, see *Customization basics* on page 33.

Note:

For Windows Vista, XP, and Macintosh OS X, user-specific preferences are supported. After logging in, each user can customize their personal settings in the Wacom Tablet control panel. Switching to another use will automatically load the settings for that user.

LEARNING MORE ABOUT CINTIQ

See the electronic Software User's Manual for detailed information on customizing Cintiq.

To view the manual, open the Wacom Tablet control panel and click on the HELP button.

To read the Software User's Manual before installing Cintiq, first insert the Wacom Pen Tablet Driver CD into your computer's CD-ROM drive. When the software menu appears, select the USER'S MANUAL option.

You will need Adobe Reader or another .pdf viewer to view the manual.

CUSTOMIZATION BASICS

This manual only covers the basics of customizing Cintiq. For detailed information see the Cintiq Software User's Manual.

Open the Wacom Tablet control panel to customize your product. When you open the control panel, an icon for the Grip Pen is displayed in the TOOL list and the appropriate tabs are displayed. To customize the pen, make your changes to the tab controls. Experiment with different settings to find what works best for you. Any changes you make will take effect immediately, but you can always click DEFAULT to return to the factory settings.

Note: Application-specific settings are for advanced users. This topic is covered in the Cintiq Software User's Manual.

The upper portion of the control panel displays icons representing your TABLET, TOOLS, and the APPLICATIONS with customized tool settings.

Closes the control panel.

Tabs display customizable settings for the selected tool.

Choose FUNCTIONS to customize your ExpressKeys, Touch Strips, and Pop-up Menu settings.

Choose GRIP PEN to customize your Grip Pen settings.

Displays a dialog box containing information about the tablet and tablet software, including an option to access the DIAGNOSTICS dialog box.

Resets the selected tab to its default settings.

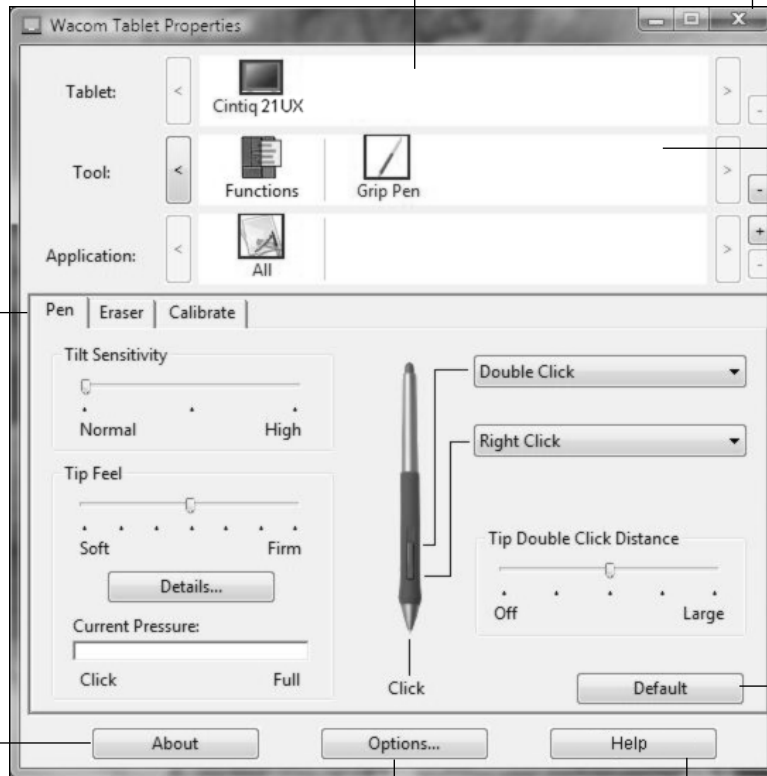

Displays advanced options.

Displays the electronic Software User's Manual.

CALIBRATING CINTIQ

You must calibrate the pen display tablet in order to align the screen cursor with the position of the pen on the display screen. This is required to adjust for parallax caused by the display screen cover glass and coating. Set Cintiq in its working position, then follow the procedure below.

Important: When using a VGA connection, make sure the Cintiq is properly adjusted before calibrating the tablet. See *Adjusting clock and phase (VGA only)* on page 39, and *Adjusting the display* beginning on page 35.

- In the Wacom Tablet control panel, select the Grip Pen from the TOOL list and then select the CALIBRATE tab.
- If you are working with multiple monitors, select the MONITOR option corresponding to the Cintiq display. (Only monitors that are set to one of the resolutions supported by Cintiq will appear in the list.)
- Click on the CALIBRATE... button to activate the calibration screen.
- Hold the pen and position your head as you normally do when working with the pen display. Use the pen tip to click on the center of the crosshairs in the upper-left corner.
- Then click on the center of the crosshairs that are displayed in the lower-right corner.
- Test the alignment by positioning the pen at a few different points on the display. Click OK to accept the calibration. Click TRY AGAIN to recalibrate.

Be sure to read the directions in the calibration screen for detailed instructions and additional options. The calibration setting applies to all applications.

Note: If more than one pen display tablet is installed on your system, be sure to select the Cintiq unit you are working with from the control panel's TABLET list.

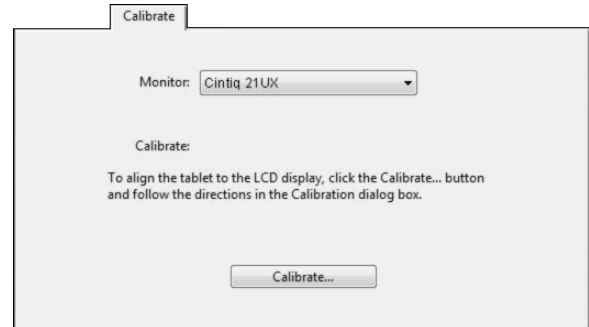

Crosshairs



Adjustment pattern for clock and phase.
See *Adjusting clock and phase (VGA only)*
on page 39 for details.

Tip: If you prefer to see the screen cursor slightly offset from the actual position of the pen tip, calibrate by clicking on a spot showing that offset from the crosshairs. For example, to have the screen cursor appear 1/10th of an inch above and to the left of the pen tip, calibrate by clicking on a spot 1/10th of an inch below and to the right of the crosshairs.

ADJUSTING THE DISPLAY

FACTORY PRESETS, AUTO-SYNC, AND USER SETTINGS

Factory presets: For optimal display quality, set your video card to Cintiq's native resolution of 1600 x 1200 pixels (UXGA). See page 63 for signal specifications.

Auto-sync: The auto-sync function automatically sets the horizontal and vertical screen position, as well as clock and phase. When connected as a VGA display, Cintiq attempts to automatically synchronize to the incoming signal. At the native resolution of 1600 x 1200, the vertical refresh frequency must be set to 60 Hz. For other resolutions, auto-sync will function when the horizontal frequency is between 31 to 92 kHz and the vertical frequency is between 56 to 85 Hz. If a specific resolution and vertical refresh frequency are not supported, you will see an "invalid mode" message. In this case choose a different resolution or refresh frequency.

If Cintiq does not automatically synchronize with the incoming signal, you can press the **AUTO** adjust button to initiate display synchronization. Additional screen display adjustments can be manually made using the OSD controls.

User settings: When you manually adjust the display using the OSD function, the settings are stored within Cintiq for use the next time the unit receives a similar signal. This is applicable to all display modes.

Color calibration: Changing the color, color temperature, contrast, brightness, or backlight from their default settings will invalidate the ICC color profile that was included on the driver CD.

ON SCREEN DISPLAY (OSD) SETTINGS

The OSD function enables you to adjust and optimize a variety of display settings at the touch of a button. The OSD controls are located on the back of the unit. Simply reach over the top of the display unit to locate the buttons with your fingers.

Note: Braille-style dots above the buttons help you to identify each one by touch.

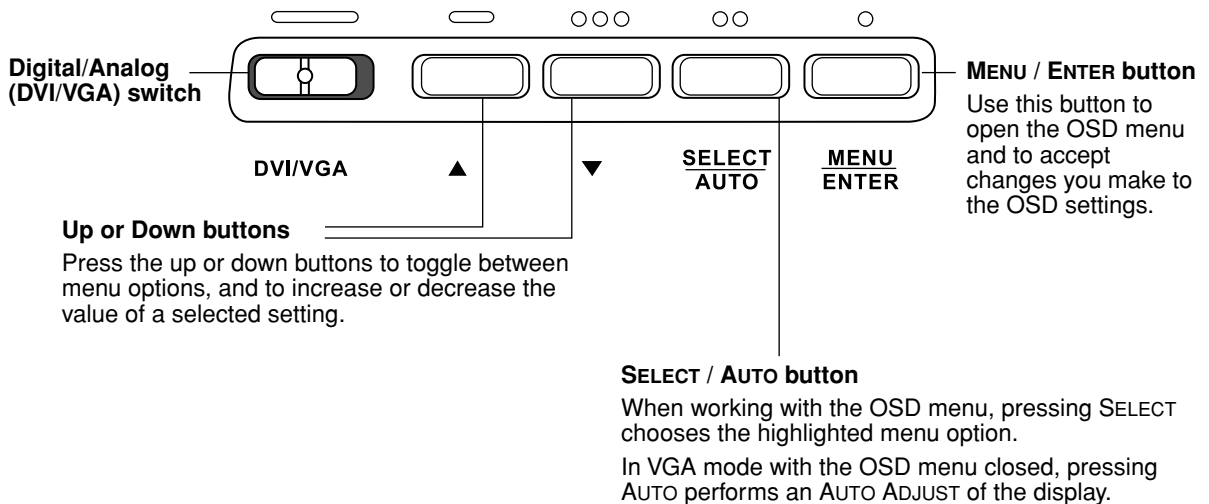

The basic process for working with the OSD is as follows:

- Press the MENU button to open the OSD main menu.
- Press the up or down buttons to toggle between the main menu icons. Then press the SELECT button to choose the highlighted icon.



The Main Control icon displays a DVI or VGA identifier, depending on which video interface is currently in use.

- Press the up or down buttons to toggle between menu options. Press the SELECT button to choose the highlighted option.



Note that some options, such as POSITION, are not available when in DVI mode.

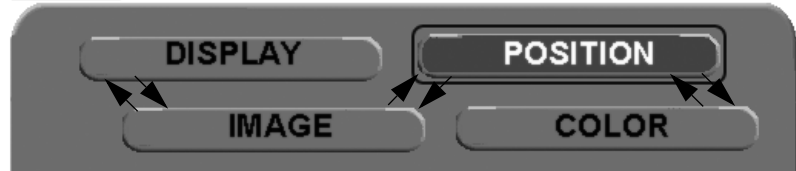

- Press the up or down buttons to select a setting for adjustment. Press the SELECT button to choose the highlighted setting.
- Note that some settings may not be available when in DVI mode.
- Use the up or down buttons to increase or decrease the setting value.
- Press the ENTER button to accept your changes.

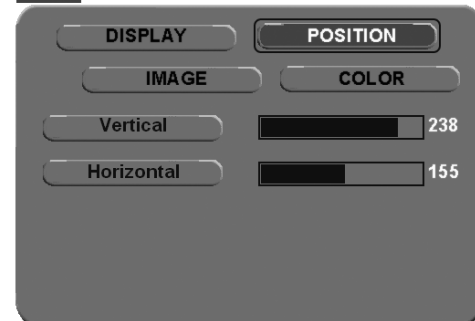

Note: After changing a setting, the OSD menu will automatically close after a few moments of inactivity. You can also continue to press ENTER in order to back out of the OSD menu. All settings are automatically saved when the OSD menu closes. If you make changes to the display appearance and cannot return to the original settings, go to the RESET menu and select the FACTORY RESET option to return Cintiq to its original factory defaults.

See the following pages for details about the OSD menu options.

When you open the On Screen Display, the main menu icons are displayed.

Main Control.

Provides options (DISPLAY, IMAGE, POSITION, and COLOR) that enable you to fine tune your display settings. See below for details.



Reset.

Returns the display parameters of the current mode to their factory default settings.

OSD Control.

Provides options that enable you to customize the OSD menu. See next page.

Language.

Allows you to choose the language in which the OSD menu will be displayed.



DISPLAY menu options are as follows:

- **BRIGHTNESS.** Increases or decreases the image brightness.
- **CONTRAST.** Increases or decreases image contrast. Note that changes in contrast may affect color accuracy.
- **BACKLIGHT.** Increases or decreases the backlight brightness level.

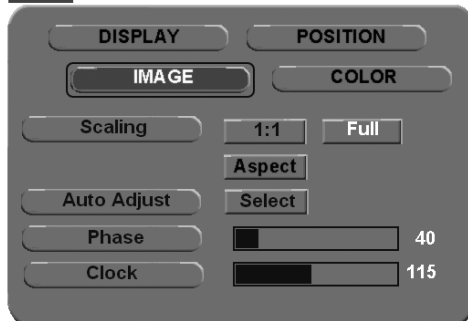
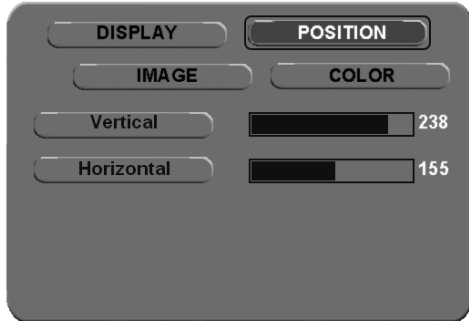

IMAGE menu options are as follows:

- **SCALING.** Enables you to choose how the image is displayed when working at resolutions below 1600 x 1200. 1:1 displays the image at the actual resolution. FULL resizes the image to fill the whole screen. ASPECT resizes the image to fill as much of the screen as possible while maintaining the correct aspect ratio.
- **AUTO ADJUST.** (VGA only.) Choose this function to automatically optimize the display screen image.
- **PHASE.** (VGA only.) Synchronizes the signal timing of the pen display to that of your graphics card. Use this adjustment when you experience an unstable or flickering image, or horizontal distortion lines.
- **CLOCK.** (VGA only.) Changes the display data frequency to match that of your graphics card. Use this adjustment when you experience an unstable or flickering image, or vertical distortion lines.



POSITION menu options (VGA only) are as follows:

- **VERTICAL.** Changes the vertical position of the image. To automatically adjust, use the **AUTO ADJUST** option.
- **HORIZONTAL.** Changes the horizontal position of the image. To automatically adjust, use the **AUTO ADJUST** option.

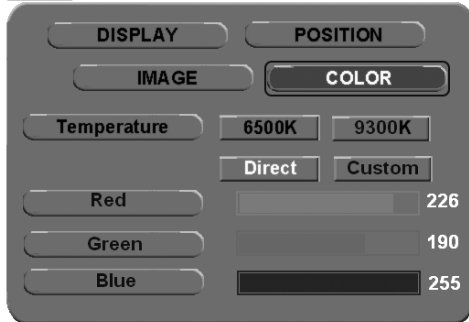

COLOR menu options are as follows:

- **TEMPERATURE.** Enables you to adjust the pen display color temperature. Provides color temperature settings for 6500° and 9300° Kelvin, as well as **DIRECT** and **CUSTOM** options.
- **DIRECT** displays the colors directly from the video card without any adjustment.
- **RED, GREEN, BLUE.** After selecting the **CUSTOM** color option, you can independently adjust the **RED, GREEN, and BLUE** display colors.

Note: Manual changes made to the color settings will invalidate the Cintiq color profile.

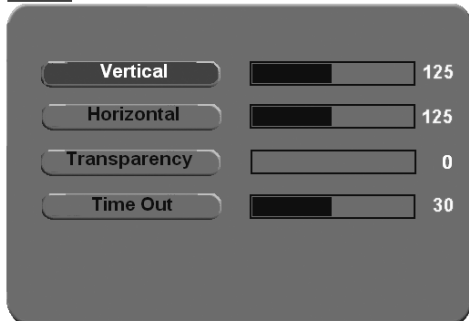

OSD Control menu options are as follows:

- **VERTICAL.** Adjusts the vertical position of the OSD menu window.
- **HORIZONTAL.** Adjusts the horizontal position of the OSD menu window.
- **TRANSPARENCY.** Changes the opaqueness of the OSD menu background.
- **TIME OUT.** Use this option to set the amount of time the OSD menu will remain displayed with no user input.

ADJUSTING CLOCK AND PHASE (VGA ONLY)

Some computers and video cards may not allow the auto-sync function to fully work when Cintiq is first connected. If some portion of text appears blurred, press the AUTO button to automatically synchronize to the incoming signal (refer to the description about auto-sync on page 35). If the image is still blurred, adjust the clock and phase manually by following the procedure below. For optimal display quality, set your video card to Cintiq's native resolution of 1600 x 1200 pixels.

- In the Wacom Tablet control panel, select the CALIBRATE tab.
- If you are working with multiple displays, be sure the display corresponding to Cintiq is selected in the MONITOR menu.
- Click on the CALIBRATE... button to activate the calibration screen.
- Using the OSD controls, open the OSD main menu. Select the IMAGE and CLOCK options, then adjust the clock level so that the pattern of fine vertical stripes displays evenly. (For details on changing the OSD settings, see *On Screen Display (OSD) settings* on page 35.)
- Next, in the OSD menu select the IMAGE and PHASE options. Adjust the phase level so that the adjustment pattern shows clearly.
- After completing these adjustments, exit the OSD menu.
- Click on the CANCEL button or press ESC to exit the calibration screen.

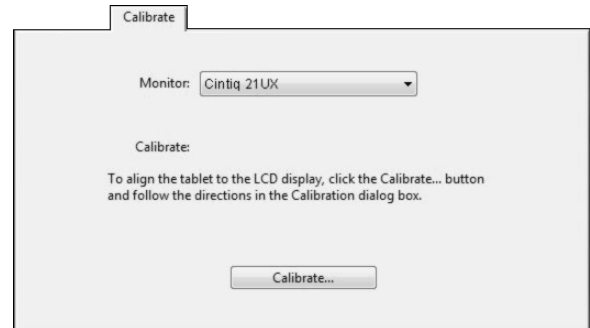

Adjustment pattern for clock and phase.

POWER SAVING

Cintiq conforms to VESA and ENERGY STAR® power saving guidelines.

When using Cintiq with a Display Power Management Signaling (DPMS) compliant computer or video card, the display will automatically comply with the below power saving parameters. When these power-saving functions are in effect, the screen display is darker than usual.

Computer mode	H-sync	V-sync	Video	Power consumption	Power lamp
Power ON	Yes	Yes	Active	54 W, max.	Blue
Standby mode	No	Yes	Blanked	2 W, max.	Orange
Suspend mode	Yes	No	Blanked	2 W, max.	Orange
OFF Mode	No	No	Blanked	1 W, max.	Orange

TROUBLESHOOTING

Most of the time your pen display tablet will work flawlessly. But if you are having trouble, Wacom recommends you do the following:

1. If the Wacom tablet driver failed to load properly, first perform the recommended action in any error message that may appear on your screen. If that does not solve the problem, continue with the troubleshooting procedures in this chapter.
2. If Cintiq does not function properly, refer to the troubleshooting sections on the following pages. See also *Display troubleshooting* on page 45, or look in the *Pen tablet troubleshooting* on page 47. Your problem may be described there and you can try the solution offered.
3. Open the Wacom pen display Read Me file for late-breaking information.
4. If you are having a compatibility conflict between Cintiq and a new hardware or software product, see *Obtaining driver downloads* on page 53 for information on downloading an updated software driver. Wacom periodically updates the software driver to maintain compatibility with new products.
5. Check the FAQs (Frequently Asked Questions) on the Wacom web site for your region.
6. If you have tried the suggestions in this manual and still cannot resolve the problem, then contact Wacom for Technical Support. See the Read Me file for information on where to obtain support for your region.

TESTING CINTIQ

1. If Cintiq's power LED does not light, check the following:

- First verify that the green light on the power adapter is on. If the light is not on, check that the power cable is properly connected to the power adapter and to an active AC outlet.
- Check that the power adapter cable is securely connected to the Cintiq power cable and that the Cintiq power switch is turned on. The Cintiq power LED will glow orange or blue whenever Cintiq is on.

Important: Use only the AC adapter that came with your pen display. Other adapters may cause damage to your product.

2. If there is no display:

- Make sure that your computer is turned on. The power LED will light blue when the proper video signal is received, and orange if there is no video signal or if the computer is in a power saving mode.
- Verify that Cintiq is connected to an active DVI-I, DVI-D or VGA connector and that the DVI/VGA switch on the back of Cintiq is set to the correct video setting.
- Check that your video card has been properly installed and is functional. If you have another display that is compatible with your video card, you can connect that display to the card in order to verify that the video card is operating correctly.

3. Verify that the tablet and Grip Pen are working:

- Press the Grip Pen tip against the display and verify that the status LED lights blue.
- If the LED does not light, verify that Cintiq's USB cable is plugged into an active USB port. If Cintiq is plugged into a USB hub, try plugging Cintiq directly into the USB port on your computer.
- Be sure that the USB port to which you are connecting Cintiq has not been disabled. It may be necessary to check your system BIOS setting to verify that you have connected Cintiq to an active USB port.
- The status LED will light blue when Cintiq is registered as a USB device and the pen tip is pressed against the display.

4. Check the pen. If you cannot make a selection on the display screen with the pen:

- Test the pen by pressing the pen tip or the eraser against the surface of the pen display tablet. The status LED should light blue.
- Now, without applying pressure to the pen tip but keeping the pen within 5 mm (0.2 inch) of the pen display tablet surface, press the side switch. The status LED should again light blue.
- If the status LED does not light blue for these tests, be sure you are using the correct pen that came with Cintiq.
- See *Testing controls and input tools* on page 43 and *Testing a pen* on page 44 for more information.

If you are still having problems, you may have a defective pen or pen display.

TESTING CONTROLS AND INPUT TOOLS

If the Grip Pen, or the Cintiq ExpressKeys or Touch Strips do not work as you expect, it is a good idea to first check the assigned functions or reset them to their default conditions. A quick way to reset a pen to its default settings is to remove it from the TOOL list by clicking on the list's [–] button. After the pen has been removed, place it back onto the display screen surface and the pen will be re-added to the TOOL list with its default settings.

Open the Wacom Tablet control panel and click on the ABOUT button. In the dialog box that appears, click on the DIAGNOSE... button to open the DIAGNOSTICS dialog box. The DIAGNOSTICS dialog box displays dynamic information about the Cintiq pen display tablet and pen. This information is used when testing Cintiq and your input tool.

If more than one Cintiq unit is connected to your system, be sure to select the unit for which you are testing in the TABLET INFO column.

Note: When testing your tool buttons, if a button is set to POP-UP MENU or OPEN/RUN..., that function will occur when the button is pressed. In this case you may want to change that button's function before testing.

TESTING THE EXPRESSKEYS

1. With the DIAGNOSTICS dialog box open, observe the TABLET INFO column as you test the ExpressKeys. If you have more than one Cintiq unit connected to your system, be sure to select the unit you are testing from the TABLET INFO column.
2. Test the keys by clicking them one at a time. Each time you press a key, its number will be displayed next to either the LEFT KEYS or RIGHT KEYS category, depending on which keys group you are testing. (See *Using ExpressKeys* on page 28 for details on the button numbers reported.)

When you are done, click the CLOSE button to exit the dialog box.

TESTING THE TOUCH STRIPS

1. With the DIAGNOSTICS dialog box open, observe the TABLET INFO column as you test each Touch Strip. If you have more than one Cintiq unit connected to your system, be sure to select the unit you are testing from the TABLET INFO column.
2. Slide your finger up or down along the entire length of the Touch Strip you want to test. As you touch and move your finger along the Touch Strip, a number will indicate the current finger position for the respective Touch Strip next to LEFT TOUCH STRIP or RIGHT TOUCH STRIP.

When you are done, click the CLOSE button to exit the dialog box.

TESTING A PEN

1. While observing the POINTING DEVICE INFO column, bring your pen within 5 mm (0.2 inch) of the display screen. A value for PROXIMITY, the DEVICE NAME, DEVICE TYPE, and a DEVICE S/N (serial number) should be displayed. If you have more than one Cintiq unit connected to your system, be sure to select the unit for which you are testing a pen in the TABLET INFO column.
2. Move your tool along the tablet surface. The X and Y DATA values should change to reflect the tool position.
3. Test your pen switches. The Cintiq status LED should light blue each time you click with the tool tip, press the side switch, or press the tool's eraser to the display screen.
 - Press on the display screen surface with the tool tip – the SWITCHES state and PRESSURE value should change. (PRESSURE should change from approximately 0% with no pressure applied to approximately 100% when full pressure is applied.)
 - Next, press the side switch without pressing the tip to the tablet – the SWITCHES state should change. (For the Grip Pen, do this for both positions of the DuoSwitch.)

Pen	Tip = 1, DuoSwitch (lower position) = 2, DuoSwitch (upper position) = 3, Eraser = 1
Airbrush	Tip = 1, Side Switch = 2, Eraser = 1
4. Test tilt for the x-axis by moving the pen from a vertical position toward the right; the X TILT value should change from approximately 0 to +60. Now move the tool to the left of vertical; the X TILT value should change from approximately 0 to - 60.
5. Test the tilt for the y-axis by moving the pen from a vertical position toward the bottom of the tablet; the Y TILT value should change from approximately 0 to +60. Now move the tool toward the top of the tablet; the Y TILT value should change from approximately 0 to +60.
6. For the optional Intuos3 Art Pen, test the rotation feature by placing the pen tip on the display screen surface and slowly rotating the pen on its axis. The ROTATION value should change as you rotate the pen.
7. When you are done, click on the CLOSE button to exit the dialog box.

DISPLAY TROUBLESHOOTING

If you encounter problems with the Cintiq display, refer to the following tables; your problem may be described here and you can try the solution offered. For additional information about color issues, refer to the documentation that came with your operating system or applications.

GENERAL DISPLAY PROBLEMS

No display. The power LED is off.	<ul style="list-style-type: none">• Verify that the light on the AC power adapter is on and the power cable is securely plugged into Cintiq's power receptacle. Check that Cintiq's power switch is turned on.
No display. The power LED is lit blue.	<ul style="list-style-type: none">• Check the contrast, brightness, and backlight controls. Adjust as necessary, or open the OSD menu, go to the RESET menu and select the FACTORY RESET option.
The power LED is lit orange. No display or a "no sync" message briefly appears on your display screen.	<ul style="list-style-type: none">• Your computer may be in a power management mode. Touch the pen tip to the Cintiq display screen, move the mouse, or depress any key on your keyboard.• Turn off both your computer and the Cintiq pen display, and check the video cable for bent or broken connector pins. Then properly connect the video cable and turn on Cintiq and your computer.• Verify that the DVI/VGA switch is properly set. Restart your computer after changing the position of the switch.• Verify that the video card is properly installed.
No display or a "cable disconnect" message briefly appears on your display screen.	<ul style="list-style-type: none">• Check that your computer is turned on.• Verify that the video cable is properly connected.• Turn off both your computer and the Cintiq pen display, and check the video cable for bent or broken connector pins. Then properly reconnect the cables and turn on Cintiq and your computer.
An "invalid mode" message briefly appears on your display screen.	<ul style="list-style-type: none">• The input signal frequency is incorrectly set or not compatible with Cintiq. Set the refresh rate (vertical frequency) to 60 Hz (or between 56 and 85 Hz if you are using a resolution of less than 1600 x 1200 pixels). If your video card driver supports adjustment of the horizontal frequency, make sure it is set to some value between 31 and 92 kHz. On a single monitor system you will need to connect a different display to change the refresh rate.• The resolution is set too high (1600 x 1200, maximum).• Set the display properties to detect plug and play monitors.
The image appears multiple times on the display.	<ul style="list-style-type: none">• Do not extend the video cable. Do not use an input selector switch box.
When a still image is displayed for a long period of time without refreshing the screen, an after-image remains for a short period of time.	<ul style="list-style-type: none">• Use a screen saver or other power management feature.

Color quality is inaccurate.

- Open the OSD menu, go to the RESET menu, and select the FACTORY RESET option.
- Be sure the Cintiq color profile has been installed and is selected as the profile for use with your operating system and applications.
- Any changes to the contrast setting should be made in small increments as changes in contrast may affect color accuracy.

The color white does not display as white.

- Be sure the Cintiq color profile has been installed and is selected as the profile for use with your operating system and applications.
- Verify also that the display is operating at the factory default settings. If that is not sufficient, then adjust color as necessary. For details on color management, refer to your operating system and application documentation.
- Verify that the video cable and connector are fully connected.

VGA PROBLEMS

The display ripples or flickers.

- Press the AUTO adjust button located on the back of the Cintiq display. Then, if necessary, open the OSD menu and manually adjust the clock and phase settings.
- Verify that the display adapter or video card matches the specifications for Cintiq.
- Adjust the refresh rate in the Display Properties control panel.

The display is not clear. Text or other portions of the screen appear blurred.

- Set the display resolution of your video card to 1600 x 1200.
- Turn off the Cintiq, then turn it back on.
- Press the AUTO adjust button located on the back of the Cintiq display. As necessary, adjust brightness, clock, and phase.

The display and LCD panel are not lined up. The display size is not correct.

- Press the AUTO adjust button located on the back of the Cintiq display.
- Open the OSD menu, and as necessary adjust clock and phase, and horizontal and vertical position. Note that some video cards may not show the display in proper sizing.

The display ripples or shows a moiré pattern. The display color is not even.

- Press the AUTO adjust button located on the back of the Cintiq display. If this does not solve the problem, go to the RESET menu and select the FACTORY RESET option to set the display back to the factory default settings.
- Open the OSD menu, and as necessary adjust clock and phase.

PEN TABLET TROUBLESHOOTING

If you encounter problems with the Cintiq pen display, refer to the following tables. Your problem may be described here, and you can try the solution offered. Be sure you refer to the Cintiq Read Me file for the latest information.

For additional information, visit Wacom's web site at <http://www.wacom.com/productsupport>.

GENERAL PROBLEMS

The computer does not have an available USB port.	Check if there is an available USB port on a USB hub. If not available, you will need to add a USB hub or USB card.
The pen display power LED is off.	Make sure the pen display power switch is turned on. Check that the AC power adapter is plugged into both the pen display and an active power outlet and that the green light on the power adapter is on. Use only the power adapter that came with the pen display; other adapters may cause damage to your product.
The pen works only in mouse mode, and does not draw with pressure sensitivity.	The tablet driver software was not installed or did not load properly. Make sure the tablet driver software is installed and functioning. Install the pen tablet driver software in accordance with the instructions found in the <i>Installation</i> section of this manual.
The pen does not draw with pressure sensitivity.	Some applications require that you turn on the pressure capabilities within the application or selected tool before the pen will respond as a pressure-sensitive tool.
Clicking is difficult.	Open the Wacom Tablet control panel and go to the PEN tab. Try using a lighter TIP FEEL.
The pen selects everything or will not stop drawing.	Open the Wacom Tablet control panel and go to the PEN tab. Move the TIP FEEL slider toward FIRM, or select the DETAILS... button and increase the CLICK THRESHOLD setting. If this does not help, see <i>Testing Cintiq</i> on page 41.
Double-clicking is difficult.	Be sure you are quickly tapping the display screen twice in the same place on the pen display tablet's active area. Wacom recommends using the side switch to double-click. Open the Wacom Tablet control panel and go to the PEN tab. Try increasing the TIP DOUBLE CLICK DISTANCE or using a lighter TIP FEEL. Windows: Try setting your system to launch programs with a single click. See <i>Basic pen operations</i> on page 25.

The eraser selects everything or will not stop erasing.

Open the Wacom Tablet control panel and go to the ERASER tab. Move the ERASER FEEL slider toward FIRM, or select the DETAILS... button and increase the CLICK THRESHOLD setting. If this does not help, see *Testing Cintiq* on page 41.

You notice a delay at the beginning of pen strokes.

Open the Wacom Tablet control panel and go to the PEN tab. Try decreasing the TIP DOUBLE CLICK DISTANCE. If that does not work, try dragging the TIP DOUBLE CLICK DISTANCE slider to the OFF position in order to turn off double-click assist.

You have to press hard with the pen when clicking, drawing, or writing.

Open the Wacom Tablet control panel and go to the PEN tab. Move the TIP FEEL slider toward SOFT, or select the DETAILS... button and decrease the SENSITIVITY and CLICK THRESHOLD settings.

The pen tip does not function.

Be sure you are using the pen that originally came with your pen display tablet, or an Intuos3 pen. Other pens may not function properly on the Cintiq pen display.

Make sure the status LED lights blue when the pen tip is pressed. If the LED does not light, verify that the USB cable is plugged into an active USB port on your computer or on a USB hub.

If the LED still does not light, you may have defective hardware (see *Troubleshooting* on page 41).

Open the Wacom Tablet control panel. Check the control panel's PEN tab and verify that the tip is assigned to a CLICK function.

Changing the function settings for an input tool has no effect.

Make sure that you change the settings for the tool and application that you are using. See the electronic Software User's Manual for details on working with multiple tools and with application-specific settings.

The pen side switch does not work.

Be sure you are using the pen that originally came with your pen display tablet, or an Intuos3 pen. Other pens may not function properly on the Cintiq pen display.

Be sure you press the side switch when the pen tip is within 5 mm (0.2 inch) of the pen display's active area – do this without pressing down on the pen tip.

From the Wacom Tablet control panel, verify that the side switch is set to the proper function you are expecting to occur for the application (and input tool) you are using. Verify also that the SIDE SWITCH EXPERT MODE option is deselected. (This option is accessed by clicking on the control panel OPTIONS... button.)

Make sure the status LED lights blue when you press the side switch. If the LED does not light, verify that the USB cable is plugged into an active USB port on your computer or on a USB hub.

If the LED still does not light, you may have defective hardware (see *Troubleshooting* on page 41).

The pen tip and screen cursor do not properly line up.

Open the Wacom Tablet control panel and select the CALIBRATE tab. Continue with *Calibrating Cintiq* on page 34.

The screen cursor moves but it does not jump to the pen tip location when the pen is placed on the display screen, and it does not follow the pen tip when the pen is moved across the display.

Make sure the Wacom tablet driver has loaded properly by opening the Wacom Tablet control panel. If the driver did not load you will see an error message. If an error message appears, reboot your computer. If the problem persists, refer to the *Installation* instructions and reinstall the Wacom tablet software. (For Macintosh, you must restart your computer after installing the Wacom tablet driver for proper tablet operation.)

If you have customized the side switch on your pen to toggle between PEN mode and MOUSE mode, make sure that your pen display is operating in PEN mode.

When using Cintiq on a multiple monitor system, you cannot use the pen to control the other monitor(s).

Set one of the ExpressKeys to DISPLAY TOGGLE, and then press that key to cycle between pen control for the Cintiq and your other displays. See the electronic Software User's Manual for details on working with DISPLAY TOGGLE.

You can also use your pen to control the other monitors in MOUSE mode. To use MOUSE mode, first set the pen's DuoSwitch to MODE TOGGLE.... Then use the switch to toggle between PEN mode and MOUSE mode.

The line you are drawing does not line up with the location of the screen cursor.

To function properly, some applications require that the pen is set to PEN mode. Make sure the pen has not been toggled to MOUSE mode. If the pen is set to PEN mode and the problem still exists, then you may have a corrupted preferences file. Follow the instructions in the next tip to create a new preferences file.

You suspect the pen tablet preferences may be corrupted, or want to make certain that all settings are at their factory defaults.

Delete the pen tablet preferences as follows:

Windows: Click the START icon and select ALL PROGRAMS. Then select WACOM TABLET and TABLET PREFERENCE FILE UTILITY. In the dialog box that appears, click on the REMOVE MY PREFERENCE FILE button to delete the preferences for the current user. To delete preferences for multiple users on Windows Vista or XP systems, click on the REMOVE ALL PREFERENCE FILES button. Note that administrator rights are required to delete preferences for all users. Relaunch any currently open tablet-aware applications that you may be running.

Macintosh: For a single user, delete the tablet preferences by first choosing your HOME folder from the GO menu. Then open your home LIBRARY folder. Within your home LIBRARY folder, open the PREFERENCES folder and delete the COM.WACOM.WACOMTABLET.PREFS file. Log out, then log back in. When the tablet driver loads, it will create a new preferences file with the factory defaults.

For multiple users, delete all tablet preferences by first opening the main APPLICATIONS folder. Then open the WACOM TABLET folder and run the REMOVE WACOM TABLET utility. When the utility starts, click on the REMOVE ALL PREFERENCE FILES button. The tablet driver will be restarted, creating new preferences files with the factory defaults.

Recalibrate the tablet.

Note: Do not manually remove the WACOM TABLET.PREFPANE file from the main LIBRARY PREFERENCEPANES folder. This file is only to be removed when uninstalling the tablet software driver, and then only when using the REMOVE WACOM TABLET utility

The screen cursor moves erratically or jumps around on the display screen when another tablet is connected to your computer.

The tablet portion of Cintiq emits electromagnetic waves at a certain frequency. If another tablet is too closely placed to Cintiq it may interfere with screen cursor positioning. If this occurs, move the tablet further away from Cintiq.

WINDOWS-SPECIFIC PROBLEMS

After changing right- and left-handed settings in the computer's mouse control panel, the pen tip no longer functions properly.

Restart Windows for your Wacom tool settings to be correctly recognized.

MACINTOSH-SPECIFIC PROBLEMS

At startup, a dialog box appears telling you that either the driver failed to load or the tablet preferences have not yet been created.

The pen display tablet was not detected at startup. Check that the USB interface cable is securely connected to a USB port on your computer or to a USB hub. Make sure that Cintiq's power light is on and is glowing blue. If this does not correct the problem, see *Troubleshooting* on page 41.

From the GO menu, select the UTILITIES folder and launch the SYSTEM PROFILER. Select USB from the HARDWARE section of the CONTENTS list. A Wacom USB pen display model should be listed. If a pen display model is not listed, check the pen display's USB cable connection or try plugging the pen display into a different USB port.

If this does not help, contact Wacom for Technical Support. See *Technical support options* on page 52.

Inkwell does not work correctly with Cintiq.

There may be a problem with the Inkwell preferences. Remove the damaged preference files as follows. They will be recreated when you enable handwriting recognition.

1. From the Apple menu, choose SYSTEM PREFERENCES. From the System Preferences menu, choose SHOW ALL and select INK. Then turn off handwriting recognition.
2. From the GO menu, choose your HOME. Open the LIBRARY and PREFERENCES folders. Then remove the following preferences:
 - com.apple.ink.framework.plist
 - com.apple.ink.inkpad.plist
 - com.apple.ink.inkpad.sketch
3. Go back to SYSTEM PREFERENCES and INK, and then enable handwriting recognition.
4. Test the Inkwell function using your Wacom pen display tablet and pen.
5. If this procedure does not resolve your problem with Inkwell, contact Apple Support for further assistance. Wacom is not the software manufacturer for Inkwell and we are limited in our abilities to support a third-party software application.

TECHNICAL SUPPORT OPTIONS

If you have a problem with your Cintiq pen display, first check the *Installation* section in this guide to make sure the unit is installed correctly. Then review the *Troubleshooting* procedures.

If you cannot find the answer in this guide, you may find updated information about your problem in the appropriate Read Me file for your platform (located on the Wacom Pen Tablet Driver CD). You can also check the product FAQs (Frequently Asked Questions) on the Wacom web site for your region.

If you have an Internet connection you can download the latest software drivers from the Wacom web site for your region. See *Obtaining driver downloads* on page 53.

If you cannot solve the problem and you think your Wacom product is not working properly, contact the Wacom support staff for the area where your product was purchased. See the Wacom tablet Read Me file, located on the Wacom Pen Tablet Driver CD, for contact information.

When you call, you should be at your computer with the following information available:

- This manual.
- Pen display tablet serial number. (See the label on the back of the unit. You may have to rotate the unit in order to see the serial number label.)
- Driver version number. (See the Wacom Pen Tablet Driver CD or click on the Wacom Tablet control panel ABOUT button.)
- The make and model of your computer, and operating system version number.
- The make, model, and connection type of your video card.
- A list of peripheral devices attached to your computer.
- The software application and version you were using when the problem occurred.
- The exact wording of any error message that appeared on your screen.
- What happened and what you were doing when the problem occurred.
- How you tried to solve the problem.

OBTAINING DRIVER DOWNLOADS

Wacom periodically updates the pen tablet software driver to maintain compatibility with new products. If you are having a compatibility problem between your Cintiq pen display and a new hardware or software product, it may be helpful to download a new Wacom tablet software driver (when available) from the Internet.

USA, Canada, Central and South America

Worldwide Web: <http://www.wacom.com/productsupport> Driver downloads.

Europe, Middle East and Africa

Worldwide Web: <http://www.wacom.eu> Software updates.

Anonymous FTP Site: <ftp://ftp.wacom.eu/pub/> Software updates.

Japan

Worldwide Web: <http://tablet.wacom.co.jp> Software updates. (Japanese)

Asia Pacific (English)

Worldwide Web: <http://www.wacom-asia.com> Software updates. (English)

China

Worldwide Web: <http://www.wacom.com.cn> Software updates.
(Simplified Chinese)

Korea

Worldwide Web: <http://www.wacomdigital.co.kr> Software updates. (Korean)

Taiwan

Worldwide Web: <http://www.wacom.com/tw> Software updates.
(Traditional Chinese)

APPENDIX

CARING FOR CINTIQ

Keep the Grip Pen and your Cintiq LCD screen surface clean. Dust and dirt particles can stick to the pen and cause excessive wear to the display screen surface. Regular cleaning will help to prolong the life of your LCD screen surface and pen. Keep Cintiq, the Cintiq stand, and the Grip Pen in a clean, dry place and avoid extremes in temperature. Room temperature is best. Cintiq, the Cintiq stand, and the Grip Pen are not made to come apart (except where specifically indicated for removal and replacement of the pen's DuoSwitch). Taking apart the product will void your warranty.

Important: Take care never to spill liquids onto the pen display or pen. Be especially careful of getting the display, tablet ExpressKeys, Touch Strips, or pen buttons, tip, and eraser wet – they contain sensitive electronic parts that will fail if liquids enter them.

CLEANING

To clean the Cintiq casing, the Cintiq display stand, or the Grip Pen, use a soft, damp cloth; you can also dampen the cloth using a very mild soap diluted with water. Do not use paint thinner, benzene, alcohol, or other solvents to clean the unit casing or pen.

To clean the display screen, use an anti-static cloth or a slightly damp cloth. When cleaning, apply only a light amount of pressure to the display screen and do not make the surface wet. Do not use detergent to clean the display screen; this may damage the coating on the screen. Please note that damage of this kind is not covered by the manufacturer's warranty.

REPLACING THE PEN TIP

The pen tip (nib) will wear with normal use. Excessive pressure will cause the nib to wear sooner. A worn nib may damage the coating on the Cintiq display screen. To avoid this, periodic tip replacement is recommended.

When the nib gets too short or develops a sharp edge, replace it with one of the extra nibs that came with the pen.

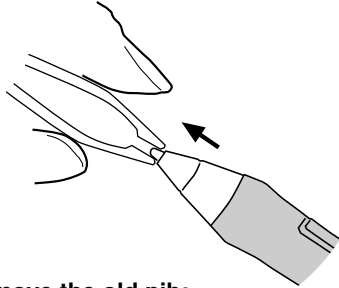

To remove the old nib:

Clasp it with a Wacom nib removal tool, pair of tweezers, needle-nosed plier, or similar instrument and pull the old nib straight out of the pen.

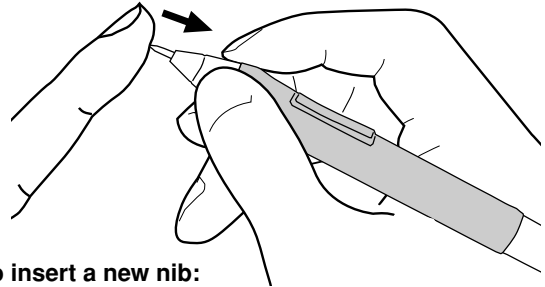

To insert a new nib:

Slide it straight into the barrel of the pen. Firmly push the nib until it stops. The new nib will slide into the correct position.



WARNING Prevent children from swallowing the pen tip or side switch. The pen tip (nib) or side switch may accidentally be pulled out if children are biting on them.

Important: When the pen is not in use, place it in the pen stand, the pen holder, or lay it flat on your desk. To maintain the sensitivity of your pen, do not store the tool in a container where it will rest on its tip or eraser.

OPTIONAL DISPLAY CONFIGURATIONS

After mounting the pen display unit on the Cintiq stand, you can rotate the pen display tablet to a variety of positions. If you do not plan to rotate the Cintiq and want to fasten it more securely to the stand, you can install the rotation lock screws as shown below.

To lock Cintiq to the display stand:

- Rotate the pen display to the standard landscape position (with the power switch located at the top of the unit).
- Two holes in the stand will line up with two screw holes on the Cintiq unit.
- Use a Phillips-head screw driver to insert the lock screws and hand-tighten them.



CAUTION Avoid placing excess physical pressure on the Cintiq stand; doing so can damage the stand.

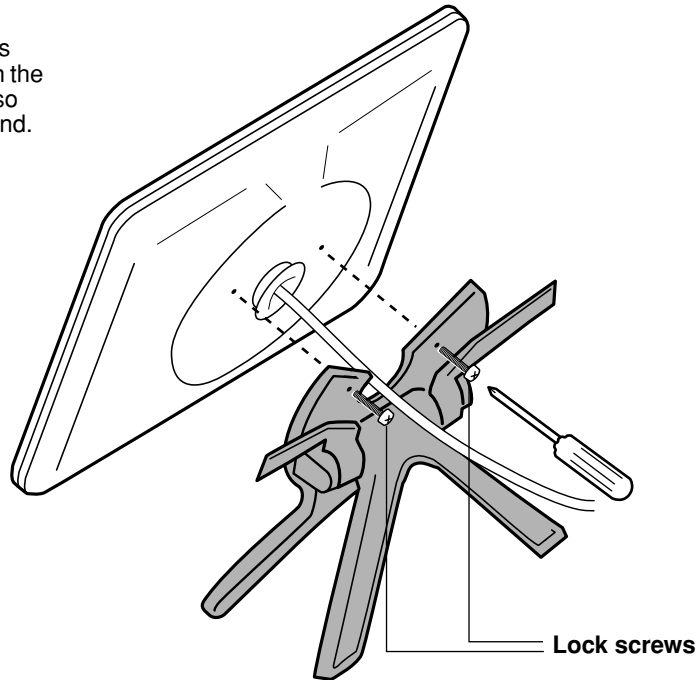

USING AN ALTERNATE MOUNT OR STAND

Cintiq can be attached to any mount arm or stand conforming to the VESA 100 standard.

Mounting screws that are 4 mm wide with a 0.7 mm pitch (M4 Regular), with a screw clearance depth from 13 – 18 mm are required.

To attach Cintiq to a VESA 100 mounting platform:

1. Turn off your computer and power off Cintiq. Then disconnect all cables from between the unit and your computer.
2. Remove Cintiq from its stand and place it face down on a flat, soft surface (such as a cloth spread across a desktop).
3. Remove the bearing hub by unscrewing the four bearing hub attachment screws. Then carefully separate the bearing halves and remove the bearing stopper to free up the cabling. **Take care not to lose the small bearing stopper** found within the inner groove of one of the hub sections.

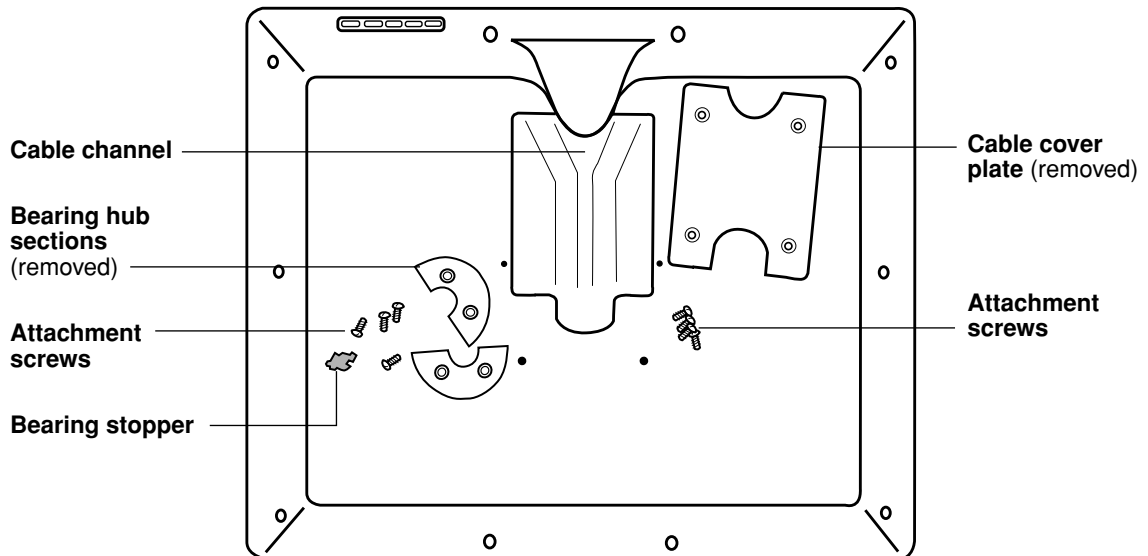
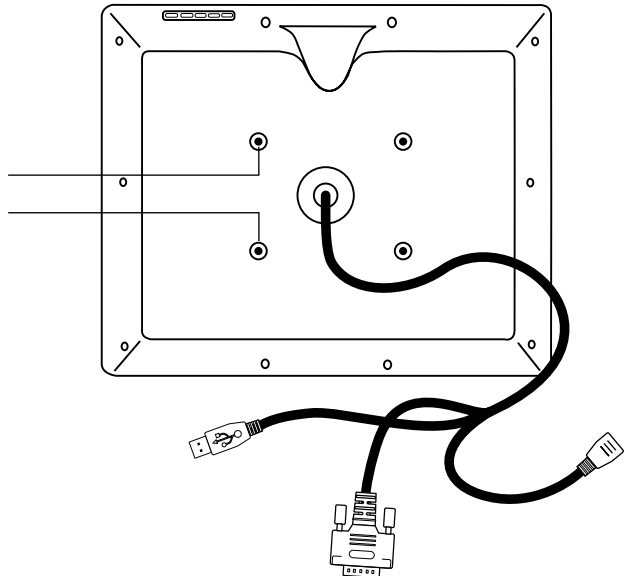

4. Next remove the four attachment screws from the cable cover plate and lift the plate away from the pen display unit.
5. Place the cable into the cable exit channel. Then reattach the cable cover plate **making sure to use the correct screws for reattachment**. (The cable cover plate screws are shorter than the bearing hub attachment screws.)
6. Using the screws that came with the bearing cover plate, install the cover plate to protect the interior of the unit from dust particles.
7. Now, using the appropriate VESA mounting screws, firmly attach Cintiq to the alternate mounting platform.

 **CAUTION** When attaching Cintiq onto an alternate mounting platform, be sure to follow all instructions in the documentation supplied by the platform manufacturer. If improperly installed, the unit could fall, resulting in damage to the unit or physical injury.

8. Refer to the *Installation* instructions beginning on page 16 and reattach the cabling to your computer.

To remove Cintiq from an alternate mounting platform:

1. Turn off your computer and power off Cintiq. Then disconnect all cables from between the unit and your computer.
2. Remove Cintiq from the alternate mounting platform.
3. Place the pen display unit face down on a flat, soft surface (such as a cloth spread across a desktop). Remove the bearing cover plate.
4. Remove the cable cover plate and lift the cable out of the cable channel. After freeing up the cable, replace the cable cover plate.
5. Lay out and study the bearing hub components – you should have two bearing hub sections, a bearing stopper, and four screws. Locate the bearing stopper within one of the bearing hub sections. (Either hub section can be used, as they are identical parts.) When correctly placed, the bearing stopper will shift smoothly from side to side within the stopper groove. The stopper will also sit flush with the rear hub surface.

Illustrates correct location of bearing stopper within bearing hub section.

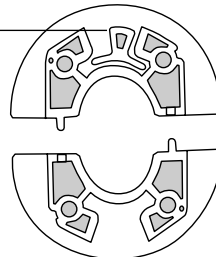

6. Taking care not to dislodge the bearing stopper from the hub section, position the two halves of the bearing hub together around the pen display tablet cable and over their attachment points.

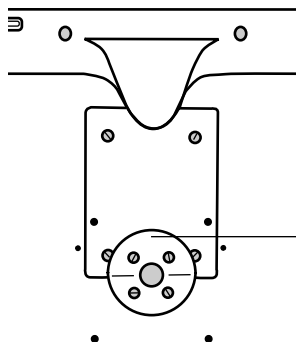

Proper positioning shows the hub sections aligned along the horizontal axis of the pen display tablet.

The section containing the bearing stopper should be positioned toward the top of the pen display tablet.

7. Attach the bearing hub sections to the unit making sure to use the correct screws for reattachment. (The bearing hub screws are longer than the cable cover plate screws.)

PEN AND DIGITAL INK CAPABILITIES IN WINDOWS VISTA

Microsoft Windows Vista provides extensive support for pen and touch input. When using Cintiq with a computer running Windows Vista, your experience is enhanced by powerful note taking, handwriting recognition, fast navigation, and other digital inking options designed to give you quick, intuitive results with the Wacom pen.

- **Note taking.** Use your Wacom pen to jot notes and capture quick sketches in Windows Journal. Journal simulates a physical notebook, but with the advantages of digital note taking – you can choose from a variety of pen, marker, and highlighter tools, plus an eraser that is easily activated by the eraser end of your Wacom pen. Journal also includes a powerful search engine that can even locate your handwritten content.
- **Handwriting recognition.** Because Windows Vista includes powerful handwriting recognition capabilities, you can use your Wacom pen to quickly enter handwritten information anywhere the computer accepts typed input. You can convert your handwritten content to typed text at any time.
- **Gestures.** Use your Wacom pen to make simple gestural movements on the tablet to trigger customizable actions for navigation, editing, and other functions. To customize your gestures, select the FLICKS tab in the PEN AND INPUT DEVICES control panel.
- **Digital Ink in Microsoft Office 2007.** Use your Wacom pen to full advantage with the enhanced digital mark-up and inking tools available in Microsoft Office 2007 applications running on Windows Vista. Found on the REVIEW tab within applicable applications, these tools provide a consistent set of inking options. For quick access, you can add specific inking tools to the Quick Access Toolbar located at the top of each application.

Note that the following workarounds in the pen tablet driver improve drawing performance in Vista:

- The Vista Pen Flicks and 'press-and-hold-to-right-click' features are disabled in graphics applications using the Wintab API.
- There is no pressure sensitivity in Journal and other Vista Ink features when both the Flicks and 'press-and-hold-to-right-click' features are disabled in the Vista PEN AND INPUT DEVICES control panel.

ABOUT THE WINDOWS VISTA TABLET PC INPUT PANEL

The Windows Vista Tablet PC Input Panel enables you to use handwriting or an on-screen keyboard to directly enter text with your Wacom pen. There are a number of ways to launch the Input Panel:

- Click on the Input Panel icon which appears when you move the screen cursor into a text entry area.
- Click on the Input Panel tab, located by default on the left edge of the display screen.
- Click on the Tablet PC Input Panel icon located on the Windows taskbar. If the icon is not visible, right-click on the taskbar, select TOOLBARS, and TABLET PC INPUT PANEL.

To customize the Input Panel:

1. First open the Input Panel and then click on TOOLS in the menu bar.
2. Select OPTIONS to open the Input Panel Options dialog box.
3. Customize the Input Panel settings for the way you like to work.

To learn more about using your Wacom pen in Microsoft Windows Vista and Office 2007, study the documentation that came with your system and Microsoft Office applications. Be sure to take advantage of the Windows Vista training tools, including the Tablet PC tutorial, available from Microsoft.

You can visit also the Wacom web site at www.wacom.com/vista for additional information on working with your Wacom pen in Windows Vista.

UNINSTALLING CINTIQ

Follow the appropriate procedure below to remove the Wacom tablet software and Cintiq pen display from your system.

Important: When you remove the Wacom tablet software from your system, your Wacom tablet will no longer operate with full tablet functionality but will continue to function as a mouse device.

Windows:

1. Click on the Windows START button and open the CONTROL PANEL.
2. In the CONTROL PANEL window for
 - Windows Vista: click on UNINSTALL A PROGRAM. In the dialog box that appears, choose the WACOM TABLET option and click on the UNINSTALL button.
 - Windows XP or XP x64: select ADD OR REMOVE PROGRAMS. In the ADD OR REMOVE PROGRAMS window, choose WACOM TABLET and click on the REMOVE button.
 - Windows 2000: double-click on the ADD/REMOVE PROGRAMS icon. In the dialog box that appears, choose the WACOM TABLET option and click on the ADD/REMOVE... button.
3. Follow the prompts to remove the tablet driver. (If prompted, enter your administrator login name and password.)
4. When the driver has been removed, shut down your system, power off your computer, and turn off Cintiq. When your computer and Cintiq are off, disconnect Cintiq from your computer.

Macintosh:

1. From the GO menu, choose APPLICATIONS and open the WACOM TABLET folder.
2. Double-click on the REMOVE WACOM TABLET icon and select the REMOVE TABLET SOFTWARE button. Enter your administrator login name and password.
3. After the removal is completed, click OK.
4. Shut down your computer and turn off Cintiq. When your computer and Cintiq are off, disconnect Cintiq from your computer.

PRODUCT SPECIFICATIONS

GENERAL SPECIFICATIONS

Physical dimensions (W x D x H)	561 x 421 x 61.3 mm (22.10 x 16.59 x 2.41 in), excluding stand
Weight	8.7 kg (19.1 lb), excluding stand 10.4 kg (22.9 lb), including stand
Input voltage	12 VDC
Power consumption	54 W or less (12 VDC) in normal operation mode 2 W or less (12 VDC) in suspend or standby modes 1 W or less in off mode
Operating temperature and humidity	5° to 35° C, 20 to 80% RH (non-condensing)
Storage temperature and humidity	-10° to 60° C, 20 to 90% RH (non-condensing) (maximum storage humidity is 38% at a temperature of 60° C, and maximum storage temperature is 42° C at a humidity of 90%)
Certification and compliance	FCC part 15 class B, CE, VCCI Class B, EDID 1.3, C-tick, MIC, BSMI, CCC, The European Union RoHS Directive 2002/95/EC, Industry Canada Class B

DISPLAY

Display	a-Si TFT active matrix LCD
Screen size	21.3 in diagonal, 432 x 324 mm (17.0 x 12.8 in)
Resolution	1600 x 1200 pixels (UXGA), 1280 x 1024 pixels (SXGA), 1024 x 768 pixels (XGA), 800 x 600 pixels (SGA), 640 x 480 pixels (VGA), others
Synchronization range	60 Hz vertical (for UXGA) 56 to 85 Hz vertical, 31 to 92 kHz horizontal (for resolutions less than UXGA)
Pixel pitch	0.27 x 0.27 mm (0.011 x 0.011 in)
Color depth	16.77 million colors (24 bit)
Pixels	1,920,000
Response time (refresh rate)	20 ms, typical
Brightness	220 cd/m ² (typical)
Contrast ratio	550:1
Plug and Play	DDC2B, DDC/CI, and other DVI standards
LCD quality	Each Cintiq LCD panel is produced under very stringent quality standards. Production techniques cannot guarantee an absolutely perfect TFT display. Wacom does not allow any pixel to be always white or always black. The Cintiq 21UX display contains 5.76 million sub-pixels (red, green, or blue dots). A small number of sub-pixels (13 or less) can be partially on or partially off – this does not mean the display is defective. In a partially on sub-pixel, 50% or more of the sub-pixel is always lit. In a partially off sub-pixel, 50% or more of the sub-pixel is always dark.

PEN TABLET

Reading technology	Electromagnetic resonance technology
Active area	432.0 x 324.0 mm (17.0 x 12.75 in)
Resolution	0.005 mm/point (5080 lpi)
Accuracy	±0.5 mm (±0.02 in), average
Tilt range (all pens)	±60 degrees
Reading height	5 mm (0.2 in)
Maximum report rate	145 points/sec.
ExpressKeys stroke	1 mm (0.04 in), approximately
Touch Strips	52 mm (2.0 in) x 12 mm (0.47 in)
Pressure levels	1024 levels
Communication interface	USB

DISPLAY STAND

*Patented	Patent no. 6,874,744
Physical dimensions (W x D x H)	329 x 299 x 165 mm (13.0 x 11.8 x 6.5 in)
Weight	1.7 kg (3.7 lb)
Rotation	±180°
Incline	10° to 65° from horizontal
Primary orientation	Landscape, lockable

POWER ADAPTER

Input voltage	100 to 240 VAC, 50/60 Hz
Output voltage	12 VDC, 6.67 A

GRIP PEN (MODEL ZP-501E)

Pressure sensitivity	1024 levels (tip and eraser)
Eraser tip travel	1.3 mm (0.05 in), approximately
Physical size (L x D)	175.0 x 15.0 mm (6.89 x 0.59 in)
Weight	18 g (0.63 oz), approximately
Tip refill types	Standard nib, polyacetal (part no. PSI-A007, qty 5) Stroke nib (part no. PSI-A042, qty 5) Felt nib (part no. PSI-A043, qty 5)
The Grip Pen comes equipped with three standard nibs (white) for general multi-purpose use, a spring-loaded stroke nib (gray) providing a brush-like feeling to your work, and a felt nib (black) that has a higher friction than the standard nib.	

ACCESSORIES

Airbrush. A true digital airbrush incorporating a pressure-sensitive tip and eraser, tilt sensitivity, and a fingerwheel that provides an additional degree of control over the application of digital paint. This tool also includes a programmable side switch.



ZP-400E

6D Art Pen. This pen provides rotation sensing technology with a unique chisel-shaped nib that emulates brushes, markers, and calligraphic pens. Simply by rotating the pen, a drawn line becomes narrow or broad. When the 6D Art Pen is combined with a software application supporting its feature set, the pen can produce almost any type of brush effect or marker stroke.

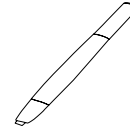

ZP-600

Classic Pen. This pressure-sensitive pen has the same feature set as the Cintiq Grip Pen, but with a slimmer profile that does not include a rubberized grip.



ZP-300E

Replacement nibs

Standard nibs, polyacetal, (white) for Grip Pen (model ZP-501E), Airbrush (model ZP-400E), or Classic Pen (model ZP-300E)

PSI-A007, qty 5

Stroke nib (gray) for Grip Pen, Airbrush, or Classic Pen. Stroke nibs are spring-loaded, providing additional tactile feedback when you are working with the Grip Pen or Airbrush. They are installed in the same manner as a standard pen nib.

PSI-A042, qty 5

Felt nib, for Grip Pen (model ZP-501E), Airbrush (model ZP-400E), or Classic Pen (model ZP-300E)

PSI-A043, qty 5

Standard nib, for Art Pen (model ZP-600)

PSI-A052, qty 5

Felt nibs, for Art Pen (model ZP-600)

PSI-A051, qty 5

Pen stand, for Grip Pen and Art Pen

PST-A034

ORDERING PARTS AND ACCESSORIES

To purchase parts and accessories, refer to the Cintiq Read Me file and see who to call for your region.

You can also do the following:

- **To purchase parts and accessories in the USA or Canada**, call 1.888.884.1870 (toll-free) or visit Wacom's web site at <http://www.WacomDirect.com> (USA only).
- **To purchase parts and accessories in Europe**, call +49 (0)180.500.03.75 or send an email to spareparts@wacom.eu. Or, visit www.wacom.eu/solutionstore. You can also contact your local dealer, distributor, or technical support using the appropriate number for your region.
- **To purchase parts and accessories in other countries**, please contact your local dealer or distributor.

Please note that not all parts and accessories are available in all regions.

RADIO AND TELEVISION INTERFERENCE

The equipment described in this manual generates, uses, and can radiate radio-frequency energy. If it is not installed and used properly – that is, in strict accordance with Wacom instructions – it may cause interference with radio and television reception.

FEDERAL COMMUNICATIONS COMMISSION (FCC) NOTICE

This device complies with Part 15 of the FCC Rules. Operation is subject to the following two conditions: (1) this device may not cause harmful interference, and (2) this device must accept any interference received, including interference that may cause undesired operation.

This equipment has been tested and found to comply with the limits for a Class B digital device, pursuant to Part 15 of FCC Rules. These limits are designed to provide reasonable protection against harmful interference in a residential installation.

This equipment generates, uses and can radiate radio frequency energy and, if not installed and used in accordance with the instructions, may cause harmful interference to radio communications. However, there is no guarantee that interference will not occur in a particular installation.

You can determine whether the equipment is causing interference by powering it off. If the interference stops, it was probably caused by the equipment.

If the equipment does cause interference to radio or television reception, you may be able to correct the interference by using one or more of the following measures:

- Rotate the television or radio antenna until the interference stops.
- Move the equipment farther away from the television or radio.
- Plug the equipment and computer into an outlet that is on a different circuit from the television or radio.

If necessary, consult your Wacom dealer or an experienced radio/television technician for help.

Changes or modifications to this product not authorized by Wacom could void the FCC Certification and negate your authority to operate the product.

INDUSTRY CANADA (CANADA ONLY)

Industry Canada, Class B

“This Class (B) digital apparatus complies with Canadian ICES-003”

“Cet appareil numérique de la classe (B) est conforme à la norme NMB-003 du Canada.”

CE DECLARATION

The Cintiq 21UX pen display has been tested and found to comply with the following harmonized European Norms:

- EN 55024: 1998+A1:2001+A2:2003 (electromagnetic immunity)
- EN 55022: 1998+A1:2000+A2:2003, Class B (electromagnetic emissions)
- EN 61000-3-2: 2000, Class D (electromagnetic emissions)
- EN 61000-3-3: 1995+A1:2001 (electromagnetic emissions)

The Wacom power adapters have been tested by their manufacturers and found to comply with the following harmonized European Norms:

- EN 55024: 1998+A1:2001 (electromagnetic immunity)
- EN 55022: 1998+A1:2000, Class B (electromagnetic emissions)
- EN 61000-3-2: 2000, Class D (electromagnetic emissions)
- EN 61000-3-3: 1995+A1: 2001 (electromagnetic emissions)
- EN 60950: 2000 (safety)

Based on the results of these tests, Wacom declares that the above mentioned device conforms to the Directive 2004/108/EC and indicates this conformity by the CE-sign on each device.

The device must be installed and operated always in strict accordance with the instructions given in this manual. Any changes or modifications to this product that were not specifically authorized by Wacom will invalidate this declaration.

WARRANTY (WORLDWIDE, EXCEPT FOR EUROPE, AFRICA AND MIDDLE EAST)

LIMITED WARRANTY

Wacom warrants the product, to the original consumer purchaser, except for the Software and consumable items such as the pen nibs, to be free from defects in materials and workmanship under normal use and service for a period of two (2) years, from the date of original retail purchase, as evidenced by a copy of the receipt and registration with Wacom within 30 days of purchase.

The Software is licensed "as is." Wacom makes no warranty with respect to its quality or performance. Wacom cannot guarantee you uninterrupted service or the correction of any errors.

Upon discovery of a defect in the product, except in the Software, within the Warranty Period, you should contact Wacom Technical Support via telephone, email, or fax to obtain an RMA (Return Merchandise Authorization) number and instructions for shipping the product to a service location designated by Wacom. You should send the product, shipping charges prepaid, to the designated service location, accompanied by the return authorization number, your name, address and telephone number, proof of purchase date, and a description of the defect. Wacom will pay for return shipping by United Parcel Service or by an equivalent service as chosen by Wacom.

Wacom's sole obligation and entire liability under this warranty shall be, at Wacom's option, either the repair or replacement of the defective product or parts thereof of which Wacom is notified during the Warranty Period; provided, however, that you are responsible for (i) the cost of transportation of the product to the designated service location and (ii) any loss or damage to the product resulting from such transportation.

Wacom shall have no responsibility to repair or replace the product if the failure of the product has resulted from accident, abuse, misuse, negligence, or unauthorized modification or repair, or if it has been handled or stored other than in accordance with Wacom's storage instructions.

Any descriptions, drawings, specifications, samples, models, bulletins, or similar material, used in connection with the sale of the product, shall not be construed as an express warranty that the product will conform or comply with your requirements.

EXCEPT FOR THE LIMITED WARRANTY DESCRIBED ABOVE, THERE ARE NO OTHER WARRANTIES MADE BY WACOM ON THIS PRODUCT. NO ORAL OR WRITTEN INFORMATION OR ADVICE GIVEN BY WACOM, ITS DEALERS, DISTRIBUTORS, AGENTS, OR EMPLOYEES SHALL CREATE A WARRANTY OR IN ANY WAY INCREASE THE SCOPE OF THIS WARRANTY, AND YOU MAY NOT RELY ON ANY SUCH INFORMATION OR ADVICE. THIS WARRANTY GIVES YOU SPECIFIC LEGAL RIGHTS, AND YOU MAY ALSO HAVE OTHER RIGHTS WHICH VARY FROM STATE TO STATE.

WACOM LIMITS THE DURATION OF ANY LEGALLY IMPLIED WARRANTIES INCLUDING IMPLIED WARRANTIES OF MERCHANTABILITY OR FITNESS FOR A PARTICULAR PURPOSE, TO THE DURATION OF WACOM'S EXPRESS WARRANTY. SOME STATES DO NOT ALLOW LIMITATIONS ON HOW LONG AN IMPLIED WARRANTY LASTS, SO THE ABOVE LIMITATION MAY NOT APPLY TO YOU.

NEITHER WACOM NOR ANYONE ELSE WHO HAS BEEN INVOLVED IN THE CREATION, PRODUCTION, OR DELIVERY OF THIS PRODUCT SHALL BE LIABLE FOR ANY DIRECT, CONSEQUENTIAL, OR INCIDENTAL DAMAGES (INCLUDING DAMAGES FOR LOSS OF BUSINESS PROFITS, BUSINESS INTERRUPTION, LOSS OF BUSINESS INFORMATION AND THE LIKE) ARISING OUT OF THE USE OF OR INABILITY TO USE SUCH PRODUCT, EVEN IF WACOM HAS BEEN ADVISED OF THE POSSIBILITY OF SUCH DAMAGES. SOME STATES DO NOT ALLOW THE EXCLUSION OR LIMITATION OF INCIDENTAL OR CONSEQUENTIAL DAMAGES, SO THE ABOVE LIMITATION OR EXCLUSION MAY NOT APPLY TO YOU.

In the event that any of the above limitations are held unenforceable, Wacom's liability for any damages to you or any party shall not exceed the purchase price you paid, regardless of the form of any claim.

This Limited Warranty is governed by the laws of the United States of America and the state of Washington.

This Limited Warranty is valid for and only applies to products purchased and used inside the United States (and its territories or possessions) and Canada.

WARRANTY SERVICE IN THE U.S.A. AND CANADA

To obtain Warranty service within the U.S. or Canada contact:

Wacom Technical Support

Phone: 1.360.896.9833

Fax: 1.360.896.9724

Inquiry form: <http://www.wacom.com/productsupport/email.cfm>

E-mail: support@wacom.com

WARRANTY SERVICE OUTSIDE OF THE U.S.A. AND CANADA

For products purchased or used outside of the United States and Canada, the warranty period is one (1) year from the date of original retail purchase. Upon discovery of a defect in the product, except in the Software, within the Warranty Period you should contact your local dealer or distributor. If an authorized Wacom repair center is not available in your local country you will be responsible for all transportation costs including duties and taxes to and from the Wacom repair center. In all other respects the terms of the warranty as set forth above apply to such sales.

Should you have any questions about this Agreement, or if you desire to contact Wacom for any reason, please contact in writing:

In North and South America contact:

Wacom Technology Corporation

1311 SE Cardinal Court

Vancouver, Washington 98683

U.S.A.

This page intentionally left blank.

This page intentionally left blank.

Wacom Technology Corporation

1311 SE Cardinal Court
Vancouver, WA 98683
U.S.A.

Telephone

General: +1.360.896.9833
Fax: +1.360.896.9724

Wacom Co., Ltd.

2-510-1 Toyonodai
Otone-Machi, Kitasaitama-Gun
Saitama, 349-1148
Japan

Internet: <http://tablet.wacom.co.jp>

Wacom China Corporation

1108 Block One, Kuntai International Bldg
12 Chao Wai Street, Chao Yang District
Beijing, China 100020

Telephone

General: +86.10.5879.0880
Fax: +86.10.5879.0102

Wacom Australia Pty. Ltd.

Level 5, 18 Orion Rd,
Lane Cove West NSW 2066, Australia

Telephone

General: +61.2.9422.6700
Fax: +61.2.9420.2272

Wacom Europe GmbH

Europark Fichtenhain A9
47807 Krefeld
Germany

Telephone

General: +49.(0)2151.3614.0
Fax: +49.(0)2151.3614.111

Wacom Co., Ltd.

Asia Pacific Office
Harmony Tower 18F, 1-32-2 Hon-Cho,
Nakano-Ku, Tokyo 164-0012
Japan

Telephone

General: +81.3.5309.1513
Fax: +81.3.5309.1514

Wacom Digital Solutions Co., Ltd.

Gangnam Telepia B/D 9th Fl, 662-18
Yeoksam-dong, Gangnam-gu, Seoul, 135-080
Korea

Telephone

General: +82.2.557.3894
Fax: +82.2.557.3895

Wacom Singapore Pte. Ltd. (Singapore)

3 Bishan Place
CPF Bishan Building #06-08
Singapore 579838

Telephone

General: +65.6258.8640
Fax: +65.6258.8697

Cintiq[®] 21UX

**Installation Guide & Hardware Manual
for Cintiq 21UX (DTZ-2100D)**